

DENTOVOS

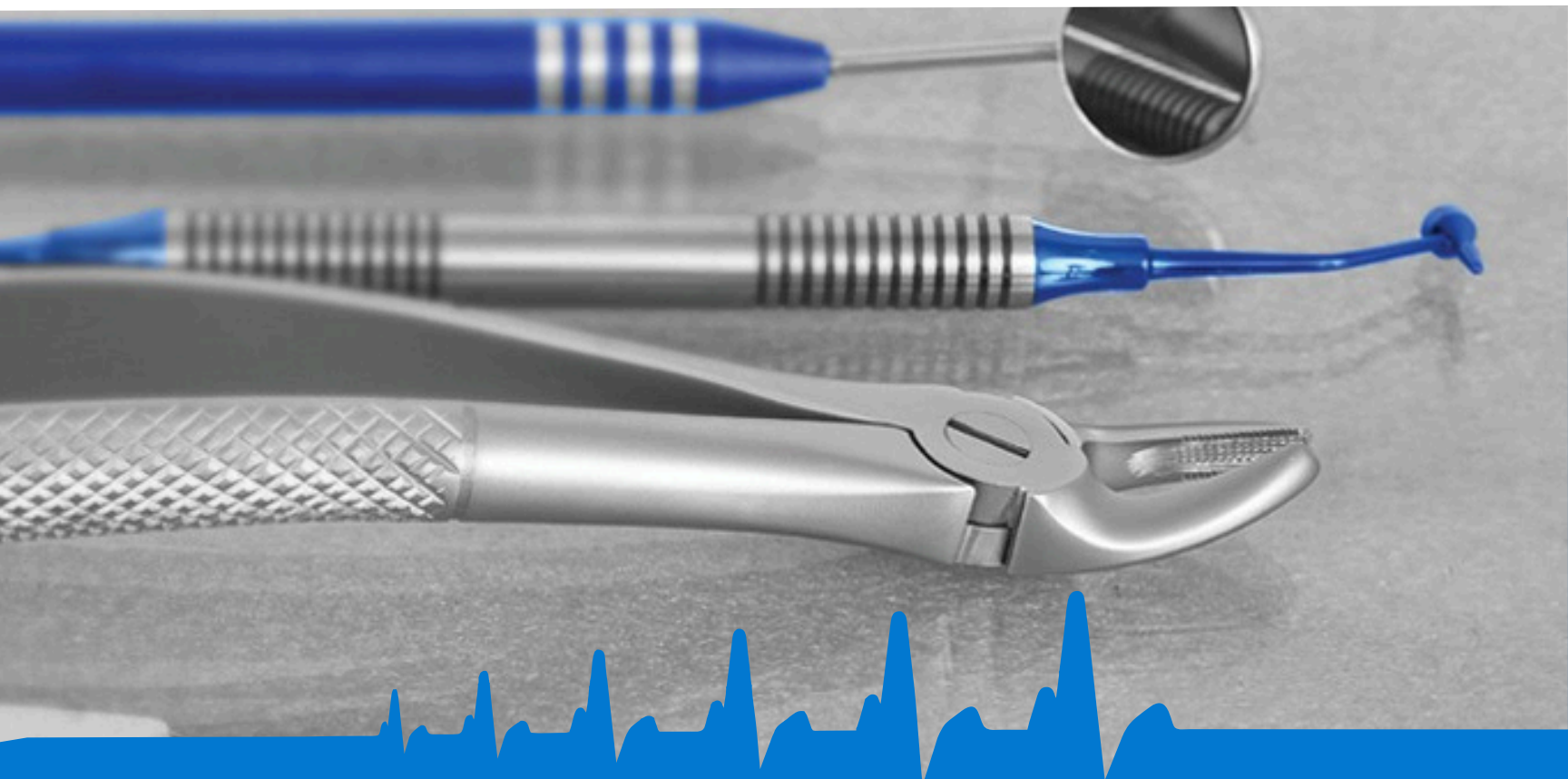

DENTAL instruments
Catalogue

Company Profile

DENTVOS INSTRUMENT Welcome you to the world of reliable quality in the products where it matters the most, to the world of precision, where lack of it could be a matter of life and death. **DENTVOS INSTRUMENTS** is an industry leader in manufacturing and providing worldwide solutions for SURGICAL/ DENTAL/ DIAGNOSTIC & HOLLOW WARE instruments. Our Professionals continually strive to satisfy your technical and clinical needs of surgical instruments. We maintain a team work environment throughout the company by placing experienced members on critical manufacturing processes in instrument craftsmanship with state-of-the-art precision manufacturing equipments and the latest technologies to achieve the highest possible results. Our instruments range from precision micro handheld surgical instruments(including forceps, clamps, scissors, needle holders, cutting and clamping devices) used in general surgery, ophthalmic, neurosurgical, ENT and cardiovascular specialties to macro instruments used in spinal, orthopedic and other surgical areas.

DENTVOS INSTRUMENTS holds worldwide recognized certifications such as:

ISO 9001	ISO 7151
CE Certified EN	ISO 17664:2004 ISO
13485:2012	13402
ISO 7153-1	ISO 15223

Which ensures our clientage that they are in best hands when it comes to quality of the instruments as well as their compliance with the international standards.

Our Quality policy ensures that every instrument is manufactured to its highest quality by maintaining quality checks at every stage, as it is our belief that our success depends on establishing enduring relationships with our customers and consistently producing high quality products that meet their demanding standards and timetables.

Production View



01

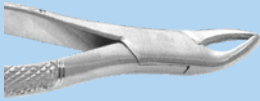

Extracting Forceps

Page 01-31

02



Root Elevators

Page 32-50

03

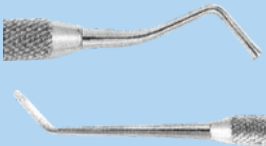

Filling Instruments

Page 51-55

04



Dental Probes

Page 56-59

05



Periodontia Instruments
Mallets

Page 60-67

06

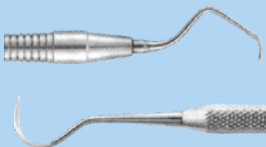

Curettes Scalers

Page 68-74

TABLE OF CONTENTS

Page 75-77

Modelling Instruments
Measuring Instruments

07



Page 78-79

Wax / Plaster Knives

08



Page 80-85

Diagnostic (Explorers)
Endodontic Instruments

09

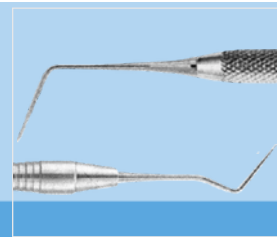

Page 86-87

Excavators

10

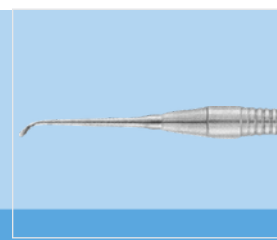

Page 88-89

Handles For Mouth Mirrors
Mouth Mirrors

11

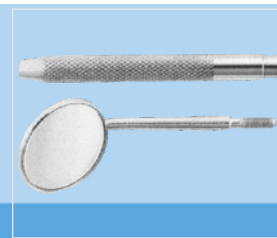

Page 90-93

Spatulas

12



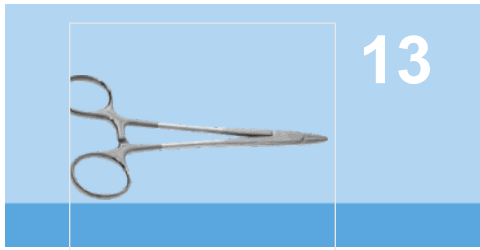

13

Needle Holders &
Saliva Ejectors

Page 94-100

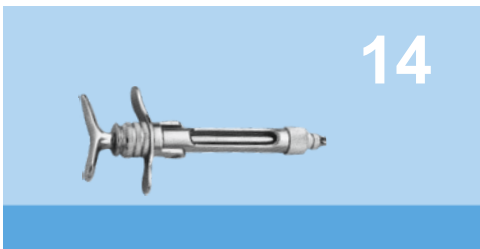

14

Syringes & Scissors

Page 101-109

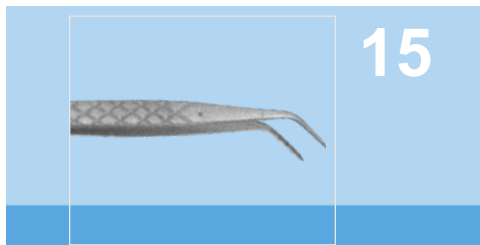

15

Dental Tweezers

Page 110-114

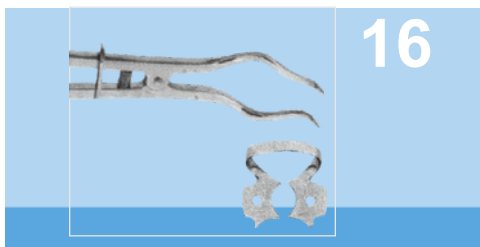

16

Rubber Dam Clamps

Page 115-117

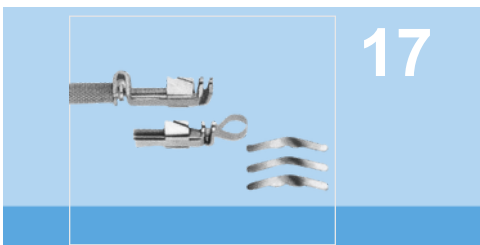

17

Matrix Retainers &
Matrix Bands

Page 118-119

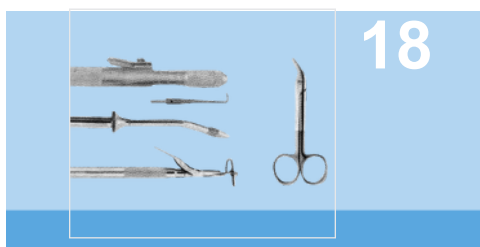

18

Crown Removers, Scissors,
Forceps, Amalgum Guns & Carriers

Page 120-122

TABLE OF CONTENTS

Page 123

Copper Ring Removing Pliers
& Paper Articulating Forceps

19



Page 124-127

Rongeurs

20

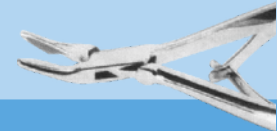

Page 128-129

Bone Elevators,
Files & Chisels

21

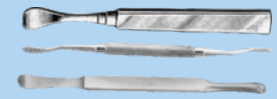

Page 130-151

Pliers For Orthodontics, Mouth Gags,
Tongue Depressors Lip and Cheek
Retractors and Implantology Instrumetns

22



Page 152-155

Impression Trays

23



Page 156-157

Articulators

24

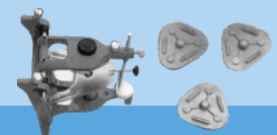

Page 158-160

Hollowares

25



DENTOVOS

Page
1-31

- ExtractingForceps-English Pattern

www.dentovos.com



DV-1-1A
Fig 8
lower premolars



DV-1-1B
Fig 13
lower premolars

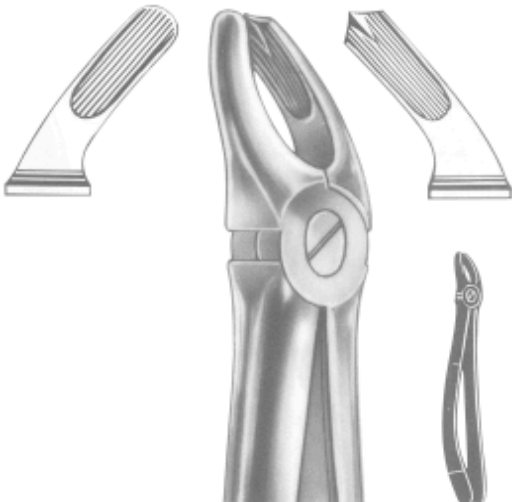

DV-1-1C
Fig 17
upper molars, right

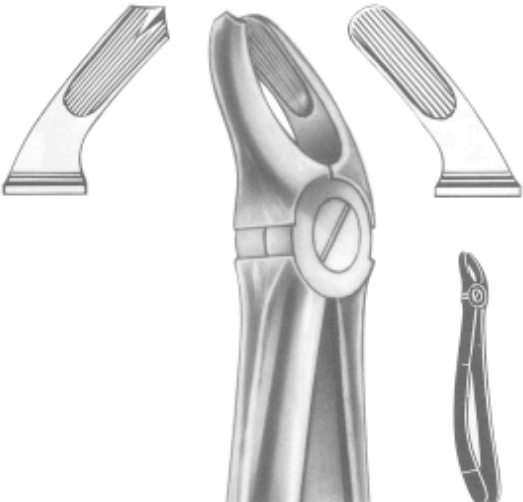

DV-1-1C
Fig 18
upper molars, left

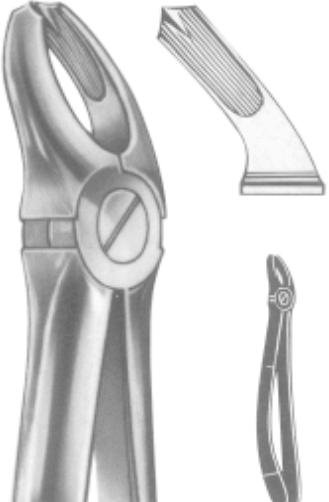

DV-1-1D
Fig 18 A
upper molars



DV-1-1E
Fig19
upper wisdoms

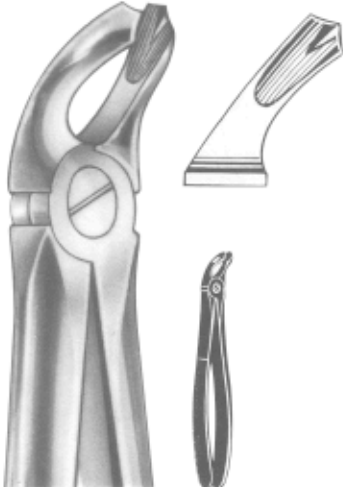

DV-1-1F
Fig 20
lower wisdoms

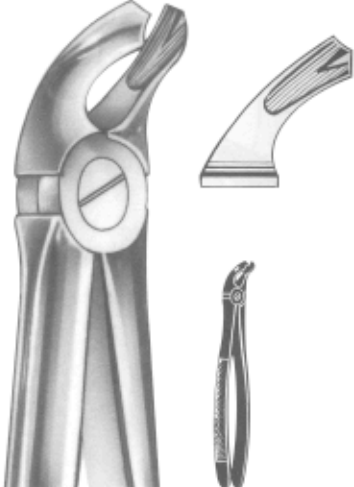

DV-1-1F
Fig 21
lower molars



DV-1-1G
Fig 22
lower molars

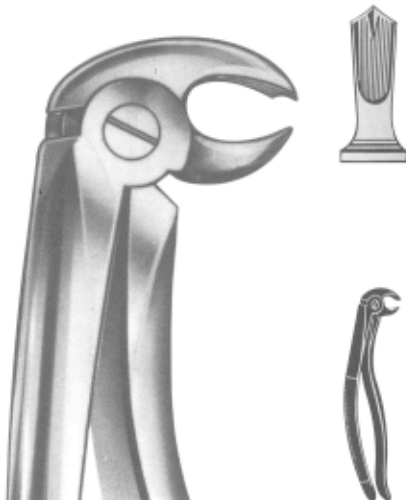

DV-1-1H
Fig 22 A
Albrecht
lower molars



DV-1-1I
Fig33 A lower roots

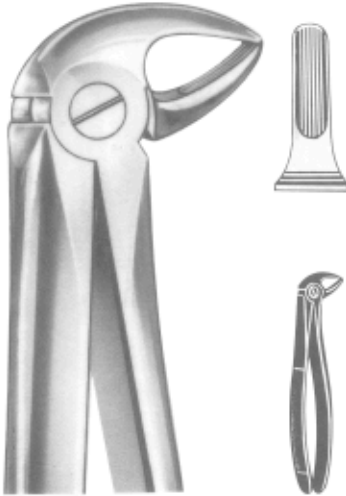

DV-1-1J
Fig33 B lower roots

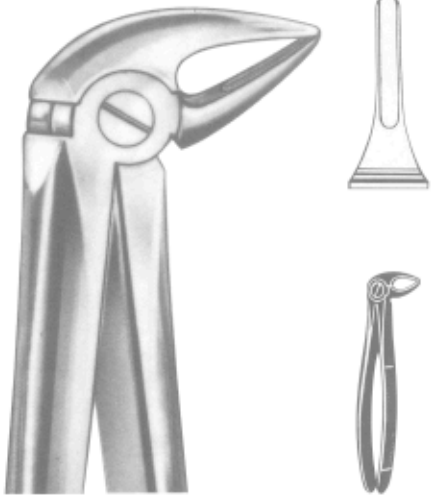

DV-1-1K
Fig33 L lower roots



DV-1-1L
Fig33 L lower roots



DV-1-1M
Fig33 S lower roots, for children



DV-1-1N
Fig 44
upper roots

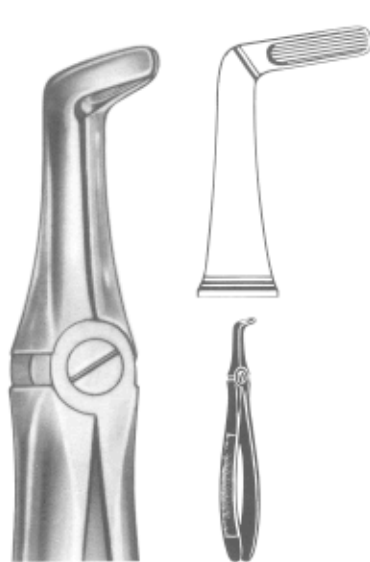

DV-1-1O
Fig 45
lower roots

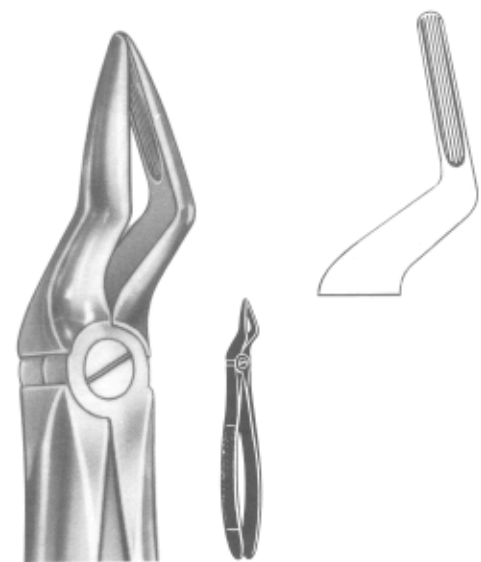

DV-1-1P
Fig 12
upper roots

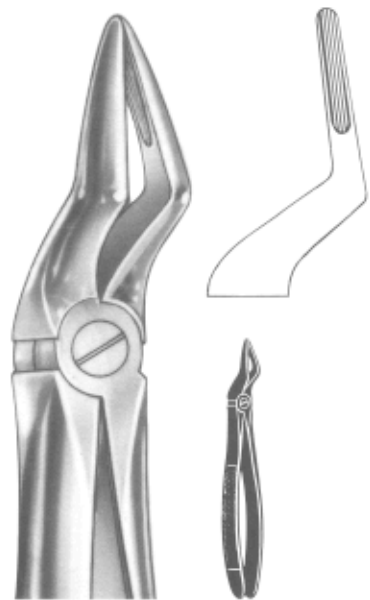

DV-1-1Q
Fig 51 A
upper roots

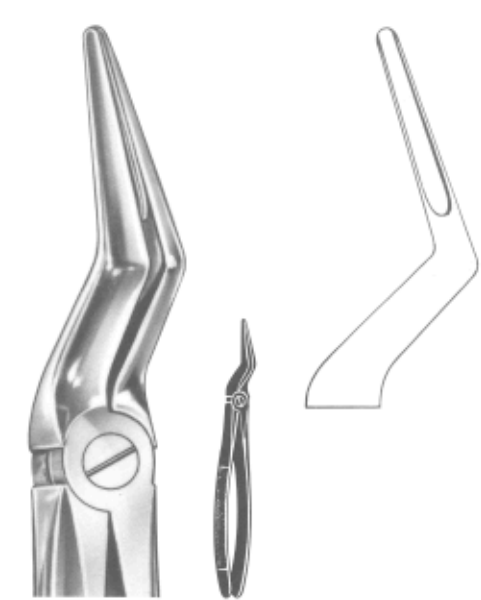

DV-1-1R
Fig 51 L
upper roots

“Relax” - Extracting Forceps



Relax DV-1-1S
Fig 51
upper roots

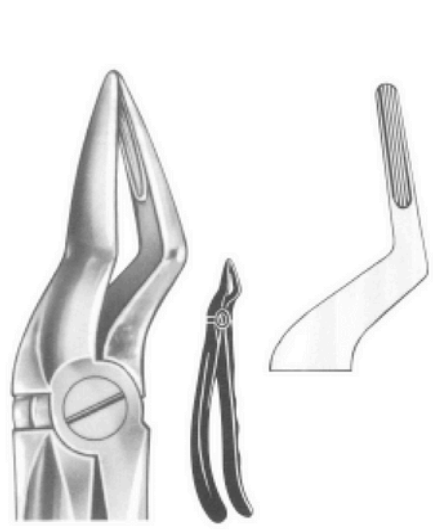

Relax DV-1-1T
Fig51 A
upper roots

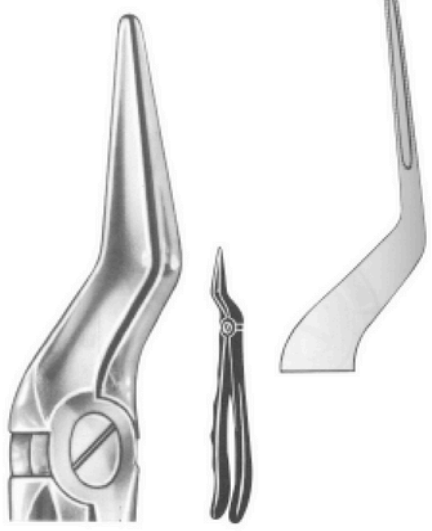

Relax DV-1-1U
Fig51 L
upper roots

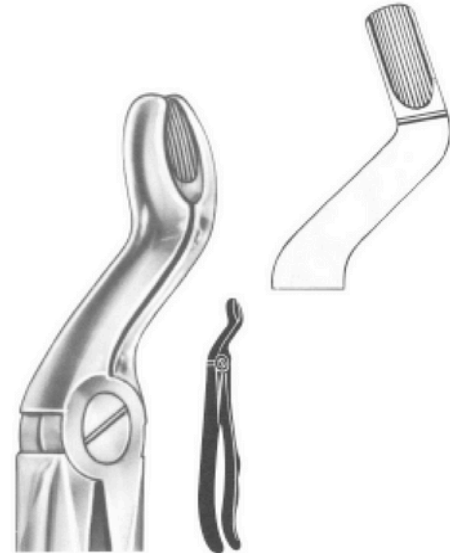

Relax DV-1-1V
Fig 67
upper wisdoms

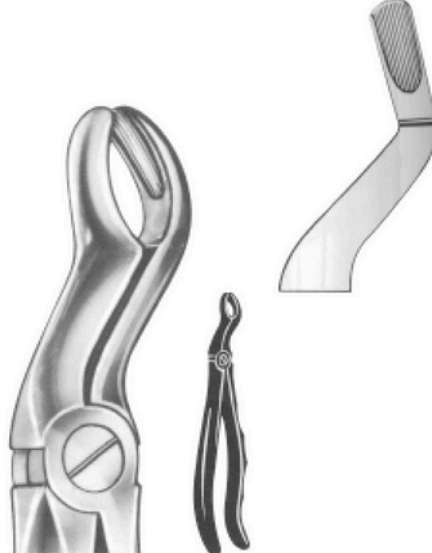

Relax DV-1-1X
Fig67 A
upper wisdoms



DV-1-1Y
Fig 37
Upper incisors

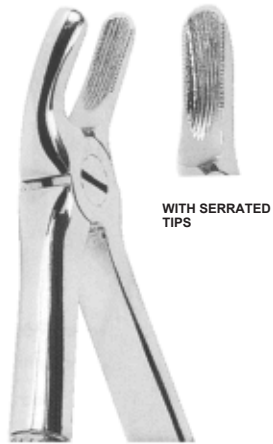

WITH SERRATED
TIPS

DV-1-1Z
Fig 39
Upper molars



WITH SERRATED
TIPS

DV-1-2A
Fig39 R
Upper molars, right

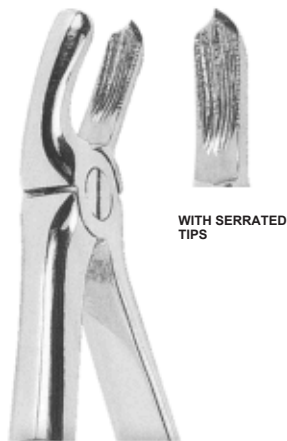

WITH SERRATED
TIPS

DV-1-2B
Fig39 L
Upper molars, left



WITH SERRATED
TIPS

DV-1-2C
Fig 515
Upper roots

Extracting Forceps For Children, English Pattern



Klein DV-1-2D
Fig 137
upper incisors



Klein DV-1-2E
Fig6
lower molars

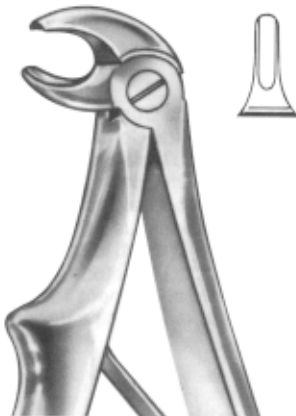

Klein DV-1-2F
Fig5
lower incisors

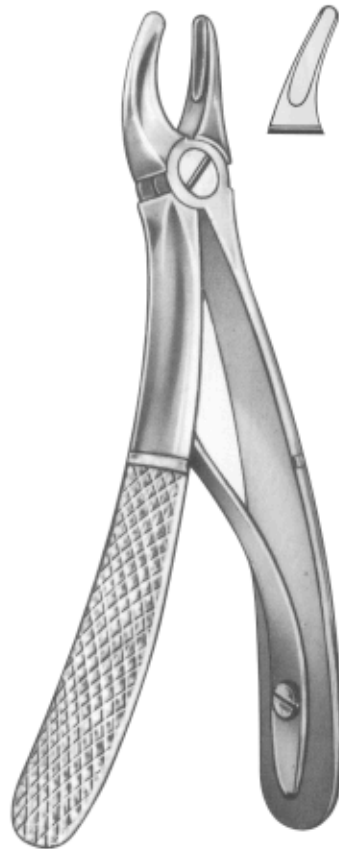

Klein DV-1-2G
Fig 139 uper
premolars



DV-1-2H
Fig 43 A
Fractured or decayed
upper teeth

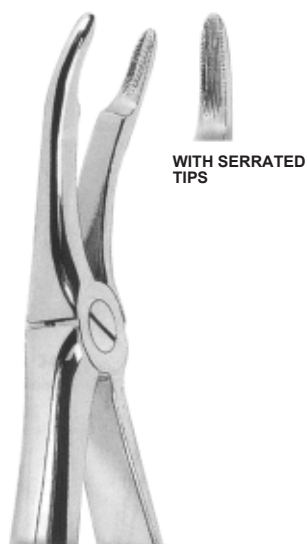

WITH SERRATED
TIPS

DV-1-2I
Fig 44
Upper roots



WITH SERRATED
TIPS

DV-1-2J
Fig 45
Lower roots

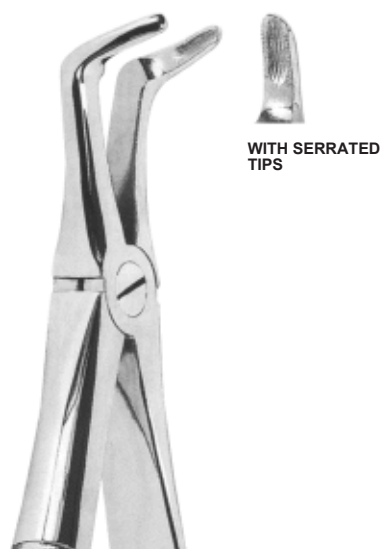

WITH SERRATED
TIPS

DV-1-2K
Fig 46
Lower roots



WITH SERRATED
TIPS

DV-1-2L
Fig46 L
Lower roots

Extracting Forceps - English Pattern



WITH SERRATED TIPS

DV-1-2M
Fig 48
Upper roots



WITH SERRATED TIPS

DV-1-2N
Fig 51
Upper roots

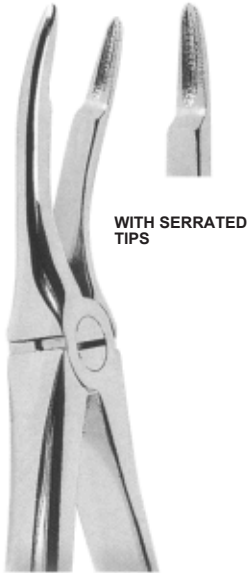

WITH SERRATED TIPS

DV-1-20
Fig 49
Upper roots



WITH SERRATED TIPS

DV-1-2P
Fig51 L
Upper roots



WITH SERRATED TIPS

DV-1-2Q
Fig51 A
Upper roots



DV-1-2R
Fig 51 LX
Upper roots



WITH SERRATED
TIPS

DV-1-2S
Fig 52
Upper roots and
canines



DV-1-2T
Fig 54 For
separating
upper molars



DV-1-2U
Fig 55 For
separating
upper molars



DV-1-2V
Fig 56 For
separating
lower molars

Extracting Forceps - English Pattern



WITH SERRATED TIPS

DV-1-2W
Fig 59
Lower roots



WITH SERRATED TIPS

DV-1-2X
Fig 59 L
Lower incisor roots

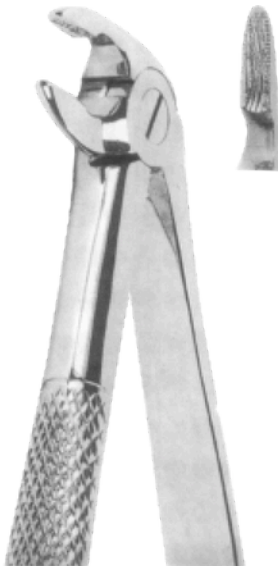

DV-1-2Y
Fig 60
Lower roots

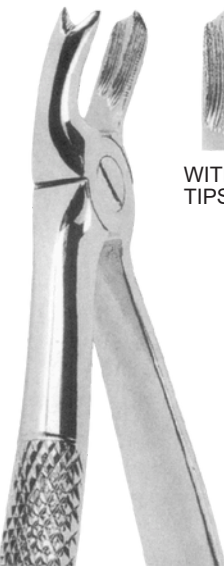

WITH SERRATED TIPS

DV-1-2Z
Fig 65 L
Upper Molars, Left



WITH SERRATED TIPS

DV-1-3A
Fig 65 R
Upper Molars, right



DV-1-3B
Fig 66 L
Upper molars, left



DV-1-3C
Fig 66 R
Upper molars, right



DV-1-3D
Fig 67
Upper third molars



DV-1-3E
Fig 67 A
Upper third molars



DV-1-3F
Fig 68
Lower roots

Extracting Forceps - English Pattern



DV-1-3G
Fig 67½ L
Upper third molars, left



DV-1-3H
Fig 67½ R
Upper third molars, right



DV-1-3I
Fig 73
Lower molars



DV-1-3J
Fig 74
Lower roots



DV-1-3K
Fig 74 M
Lower roots

Extracting Forceps - English Pattern

www.dentovos.com



WITH SERRATED TIPS

DV-1-3L
Fig74 N
Lower roots



WITH SERRATED TIPS

DV-1-3M
Fig 75 Lower
canines and
premolars



WITH SERRATED TIPS

DV-1-3N
Fig 79
Lower third molars



WITH SERRATED TIPS

DV-1-3O
Fig79 A
Lower third molars



WITH SERRATED TIPS

DV-1-3P
Fig79 C
Lower third molars

Extracting Forceps - English Pattern



DV-1-3Q
Fig 86 W
Lower third molars



DV-1-3R
Fig 86 1/2 L
Lower third molars, left



DV-1-3S
Fig 86 1/2 R
Lower third molars, right



DV-1-3T
Fig 86 C
Lower molars



DV-1-3U
Fig 87
Lower decayed molars
or broken-down crowns



WITH SERRATED
TIPS

DV-1-3V
Fig 89
Upper molars, right



WITH SERRATED
TIPS

DV-1-2X
Fig 90
Upper molars, left



WITH SERRATED
TIPS

DV-1-3Y
Fig 99
Broken-down lower molars



WITH SERRATED
TIPS

DV-1-3Z
Fig 107
Upper canines

Extracting Forceps - English Pattern



DV-1-4A
Fig 121
Upper third molars



WITH SERRATED TIPS

DV-1-4B
Fig 145
Lower roots



WITH SERRATED TIPS

DV-1-4C
Fig 151½
Upper roots

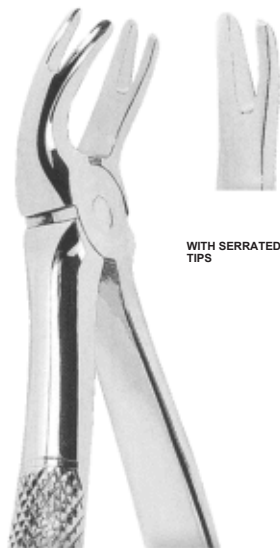

WITH SERRATED TIPS

DV-1-4D
Fig 166
Universal extracting forceps for upper teeth, in particular molars and premolars



WITH SERRATED TIPS

DV-1-4E
Fig 167
Universal extracting forceps for lower teeth, in particular molars and premolars



DV-1-4F
Fig 168
Upper canines

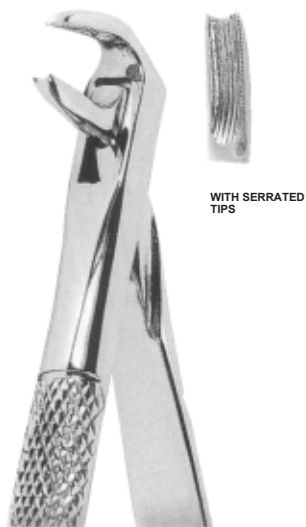

DV-1-4G
Fig 169
Lower canines



DV-1-4H
Fig 346
Lower roots

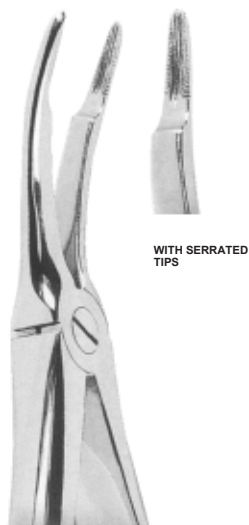

DV-1-4I
Fig 349
Upper roots



DV-1-4J
Fig 359
Lower roots

Extracting Forceps - Mead Pattern



WITH SERRATED TIPS

DV-1-4K
Fig1
Universal extracting forcep for upper incisors and canines



WITH SERRATED TIPS

DV-1-4L
Fig2
Upper molars

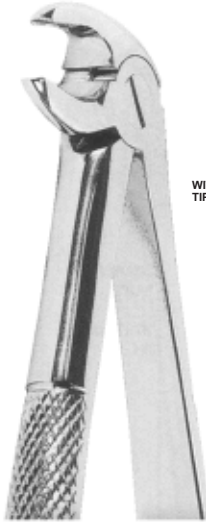

WITH SERRATED TIPS

DV-1-4M
Fig3
Lower incisors, premolar and roots

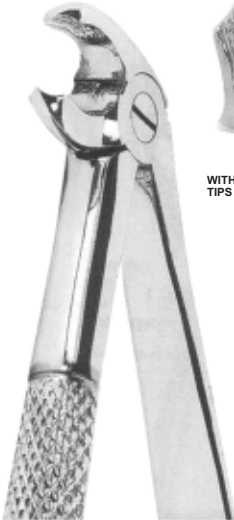

WITH SERRATED TIPS

DV-1-4N
Fig4
Lower molars



WITH SERRATED TIPS

DV-1-40
Fig1
Upper incisors
and canines



WITH SERRATED TIPS

DV-1-4P
Fig2
Upper incisors
and canines

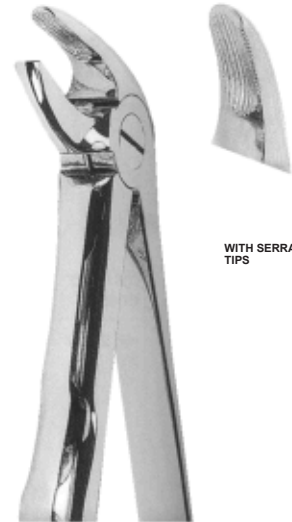

WITH SERRATED TIPS

DV-1-4Q
Fig4
Lower incisors
and canines



WITH SERRATED TIPS

DV-1-4R
Fig7
Upper premolars



WITH SERRATED TIPS

DV-1-4S
Fig 13
Lower premolars

Extracting Forceps With Anatomically Shaped Handle



DV-1-4T
Fig 17
Upper molars, right

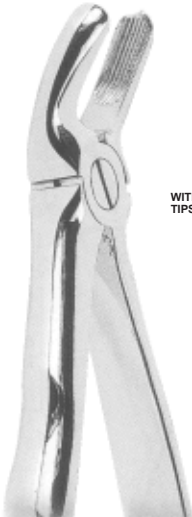

WITH SERRATED TIPS

DV-1-4U
Fig 18
Upper molars, left

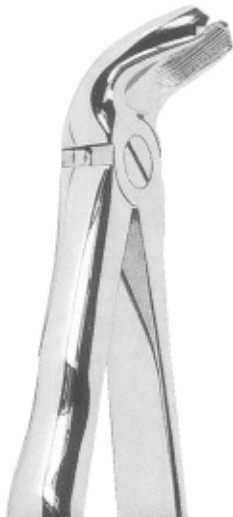

WITH SERRATED TIPS

DV-1-4V
Fig 21
Lower molars

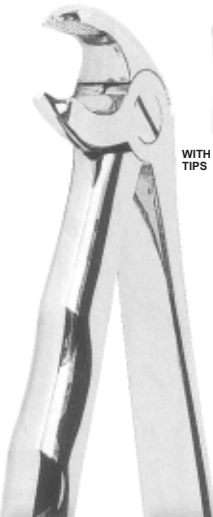

WITH SERRATED TIPS

DV-1-4X
Fig 22
Lower molars



WITH SERRATED TIPS

DV-1-4Y
Fig 33
Lower roots



DV-1-4Z
Fig 45
Lower roots



WITH SERRATED TIPS



WITH SERRATED TIPS

DV-1-5A
Fig51 A
Upper roots



WITH SERRATED TIPS

DV-1-5B
Fig67 A
Upper third molars



WITH SERRATED TIPS

DV-1-5C
Fig 74
Lower roots

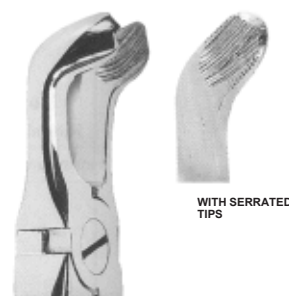

WITH SERRATED TIPS

DV-1-5D
Fig 79
Lower third molars



WITH SERRATED TIPS

DV-1-5E
Fig86 C
Lower molars



WITH SERRATED TIPS

DV-1-5F
Fig359
Lower roots

Extracting Forceps With Anatomically Shyped Handle



DV-1-5G
Fig 89
Upper molars, right

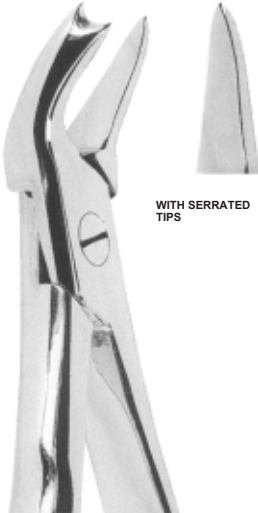

DV-1-5H
Fig 90
Upper molars, left

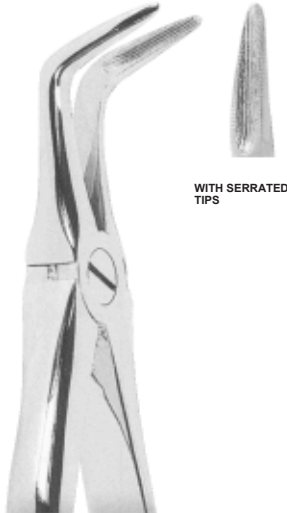

DV-1-5I
Fig 145
Lower roots



DV-1-5J
Fig 151 1/2
Upper roots

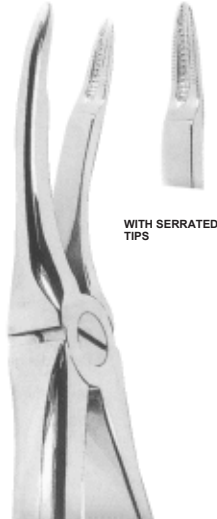

DV-1-5K
Fig 349
Upper roots



DV-1-5L
Fig5
Lower third molars



DV-1-5M
Fig6 Separating
forcep



DV-1-5N
Fig 105
Upper molars



DV-1-5O
Fig 16
Lower molars



DV-1-5P
Fig 17
Lower molars

Extracting Forceps - American Pattern



DV-1-5Q
Fig18 L
Upper molars, left



DV-1-5R
Fig18 R
Upper molars, right



DV-1-5S
Fig 23
Lower molars



DV-1-5T
Fig53 R
Upper molars, right



DV-1-5U
Fig53 L
Upper molars, left



DV-1-5V
Fig 65
Upper incisors and roots



DV-1-5X
Fig 69
Upper and lower roots



DV-1-5Y
Fig 88 R
Upper molars, right



DV-1-5Z
Fig 88 L
Upper molars, left



DV-1-6A
Fig 101
Deciduous teeth

Extracting Forceps - American Pattern



DV-1-6B
Fig 150
Upper incisors, premolars, roots

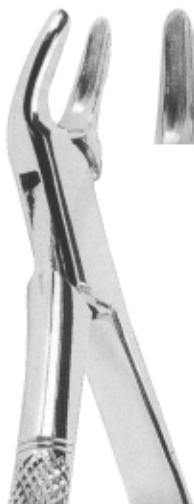

DV-1-6C
Fig 150 S
Upper teeth (for children)



DV-1-6D
Fig 151
Upper incisors, premolars, roots



DV-1-6E
Fig 151S
Lower teeth (for children)



DV-1-6F
Fig 222
Lower third molars



DV-1-6G
Fig1
upper incisors and bicuspid

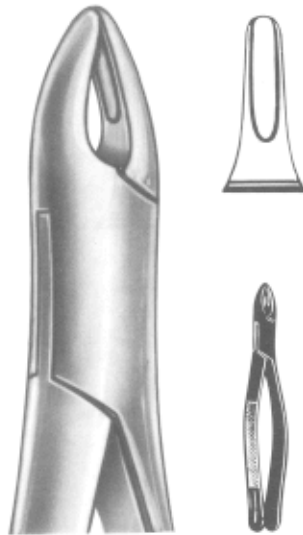

DV-1-6H
Fig1 B
upper roots, anterior

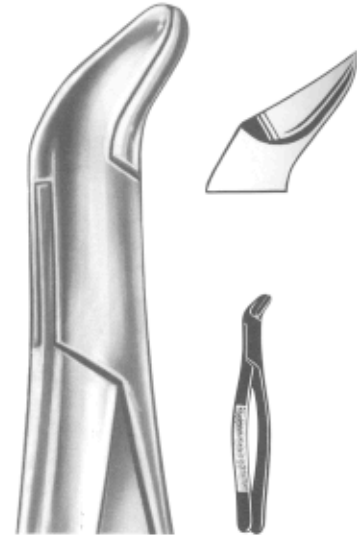

Physick DV-1-6I
Fig 5 lower
wisdoms

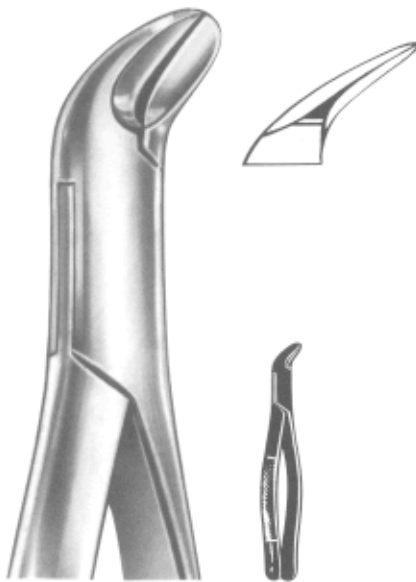

DV-1-6J
Fig 6 lower molars, splitting
forceps

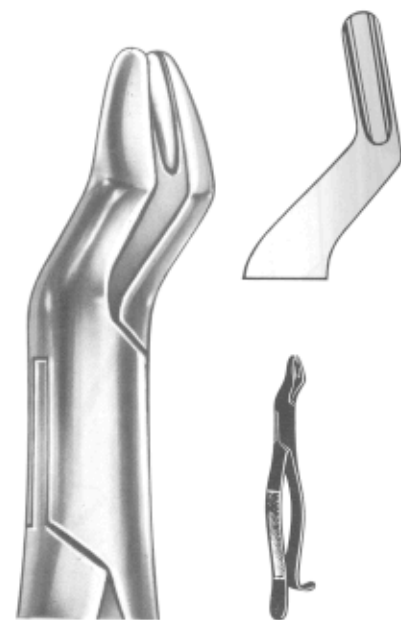

DV-1-6K
Fig10 H
upper molars

Extracting Forceps For Children - English Pattern



WITH SERRATED TIPS

DV-1-6L
Fig 135
Lower premolars



DV-1-6M
Fig 225
Lower molars

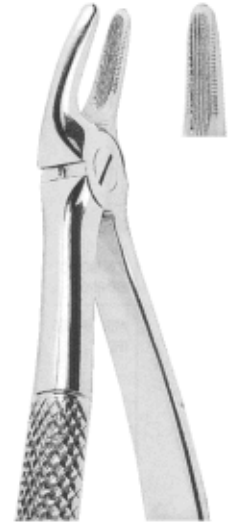

DV-1-6N
Fig 305
Upper incisors and roots



WITH SERRATED TIPS

DV-1-6O
Fig 33 S
Lower roots



WITH SERRATED TIPS

DV-1-6P
Fig 38
Lower incisors and canines



DV-1-6Q
Fig1
Upper incisors



GZ-1-5246
Fig2
Upper permolars



GZ-1-5247
Fig3
Upper molars



DV-1-6R
Fig4
Upper roots



DV-1-6S
Fig5
Lower incisors

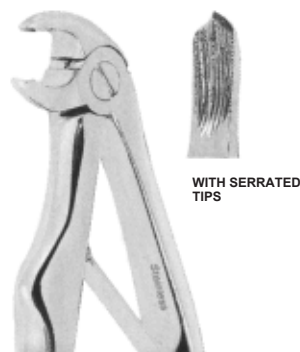

DV-1-6T
Fig6
Lower molars



DV-1-6U
Fig7
Lower roots



DV-1-6V
Fig1
Lower roots



WITH SERRATED TIPS



DV-1-6X
Fig2
Upper roots



WITH SERRATED TIPS



DV-1-6Z
Fig2
Roots fragments



DV-1-6Y
Fig1
Roots fragments

The logo for Dentovos, featuring the word "DENTOVOS" in a bold, dark blue, sans-serif font. A thin, light blue diagonal line crosses through the letter "O" from the top right to the bottom left.

Page
32-50

- RootElevators

www.dentovos.com

lower jaw, left side

lower jaw, right side

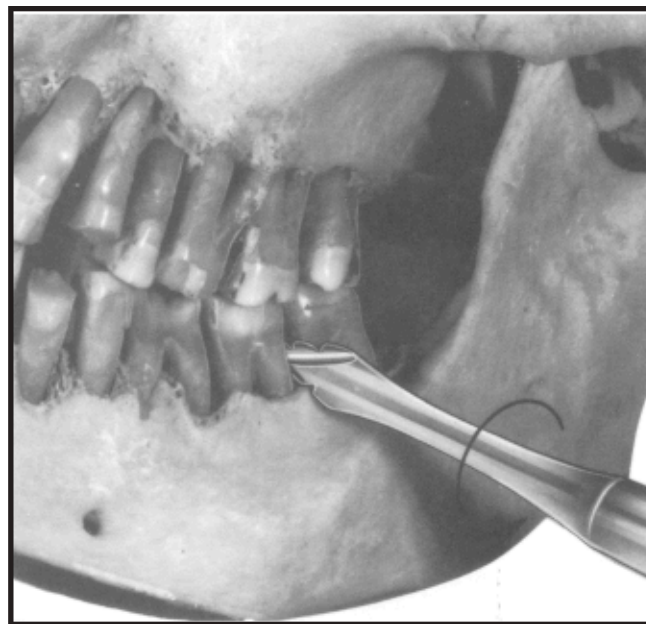

DV-2-1A



DV-2-1B

Root elevator, spiral-shaped, for extremely facilitated extraction of the molars in the lower jaw. The slender, conical points allow deep penetration between tooth and gum. Owing to the hook-shaped working parts, slipping of the elevator is avoided.



Bein

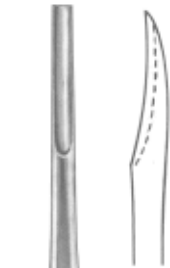

Bein DV-2-1C
Fig 1

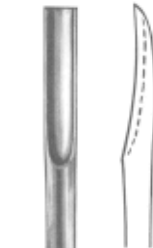

Bein DV-2-1D
Fig 2



Bein DV-2-1E
Fig 0



Bein DV-2-1F
Fig 3

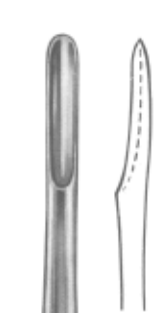

Bein DV-2-1G
Fig 4



Bein DV-2-1H
Fig 5

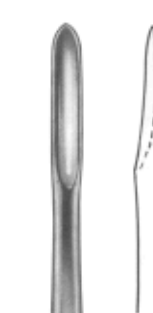

Bein DV-2-1I
Fig 6



Seldin



Seldin DV-2-1J Fig 1L



Seldin DV-2-1K Fig 1R



Seldin DV-2-1L Fig2



Seldin DV-2-1M Fig3



Seldin DV-2-1N Fig 4L



Seldin DV-2-1O Fig 4R

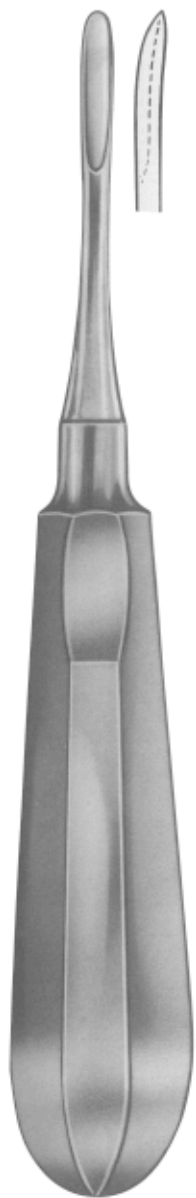

Cryer DV-2-1V
Fig3

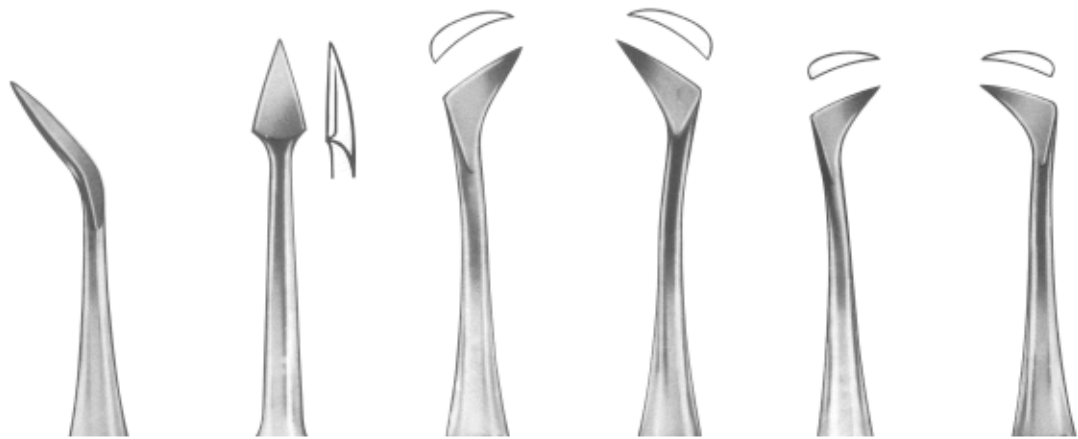

Cryer DV-2-1P
Fig4

Cryer DV-2-1Q
Fig 12

Cryer DV-2-1R
Fig 27

Cryer DV-2-1S
Fig 28

Cryer DV-2-1T
Fig 27 S

Cryer DV-2-1U
Fig 28 S



Apical



Apical DV-2-1V Fig1



Apical DV-2-1X Fig2



Apical DV-2-1Y Fig3



Apical DV-2-1Z Fig4



Cryer



Cryer DV-2-2A
Fig1



Cryer DV-2-2B
Fig2



Coupland



Coupland DV-2-2C
Fig1



Coupland DV-2-2D
Fig2



Coupland DV-2-2E
Fig3



DV-2-2F
Fig1



DV-2-2G
Fig2

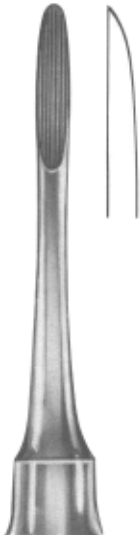

DV-2-2H
Fig3



Flohr DV-2-2I
Fig1



Flohr DV-2-2J
Fig2



Flohr DV-2-2K
Fig3

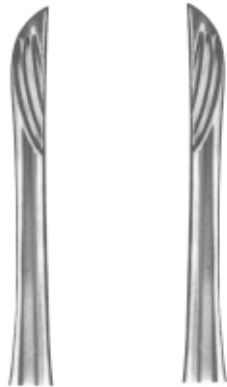

Kopp DV-2-2L
Fig1



Kopp DV-2-2M
Fig2



Kopp DV-2-2N
Fig1



Kopp DV-2-2O
Fig2



Kopp



Kopp DV-2-2P
Fig3



Kopp DV-2-2Q
Fig4



Kopp



Kopp DV-2-2R
Fig3



Kopp DV-2-2S
Fig4



Kopp DV-2-2T
Fig5



Kopp DV-2-2U
Fig6



Hylin



Hylin DV-2-2V
Fig1



Hylin DV-2-2Z
Fig2



Bein

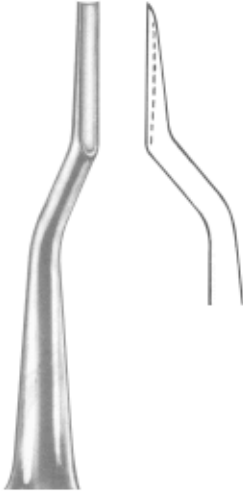

Bein DV-2-2X
Fig1

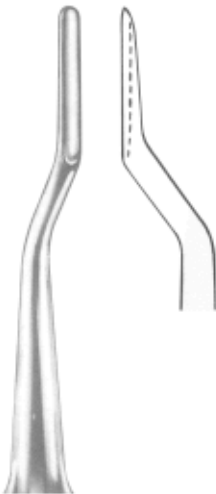

Bein DV-2-3A
Fig3

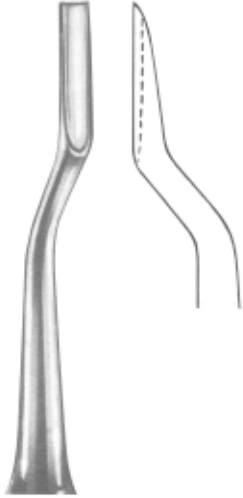

Bein DV-2-2Y
Fig2

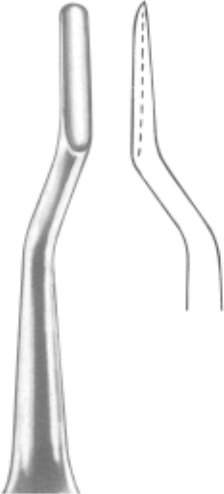

Bein DV-2-3B
Fig4



**Warwick-James
DV-2-3C
Fig1**



**Warwick-James
DV-2-3D
Fig2**



**Warwick-James
DV-2-3E
Fig3**

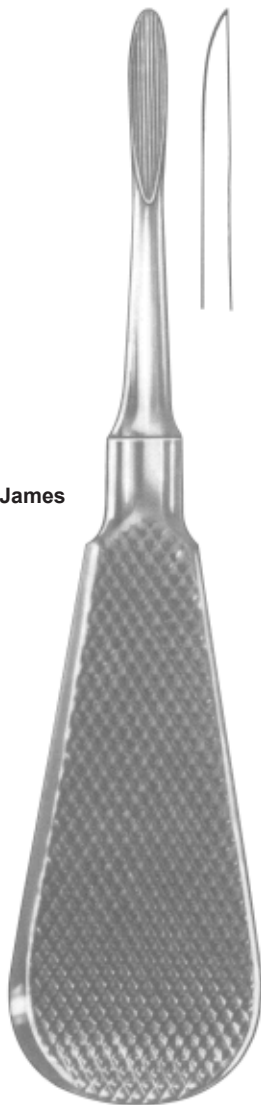

**London Hospital
DV-2-3F
Fig1**



**London Hospital
DV-2-3G
Fig2**



**London Hospital
DV-2-3H
Fig3**

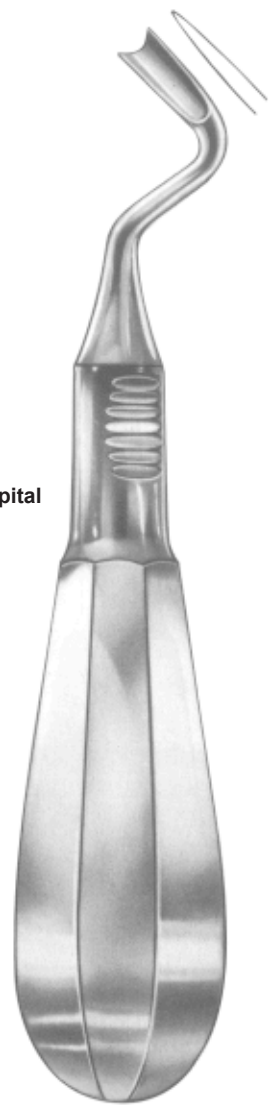

Ott DV-2-3I

Root Elevators

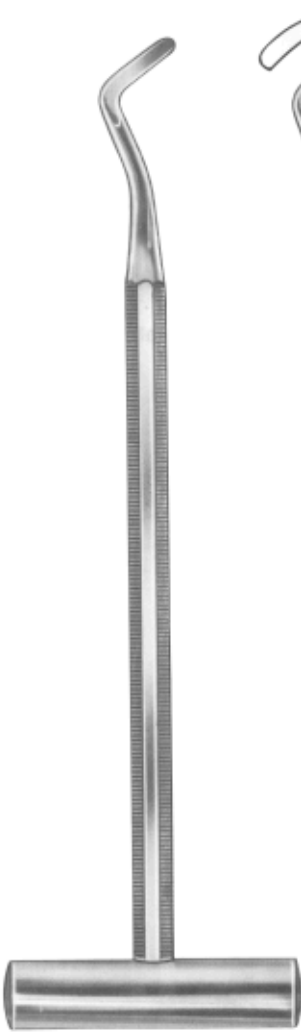

Pott



Pott DV-2-3J
Fig1



Pott DV-2-3K
Fig2



DV-2-3L
Fig1

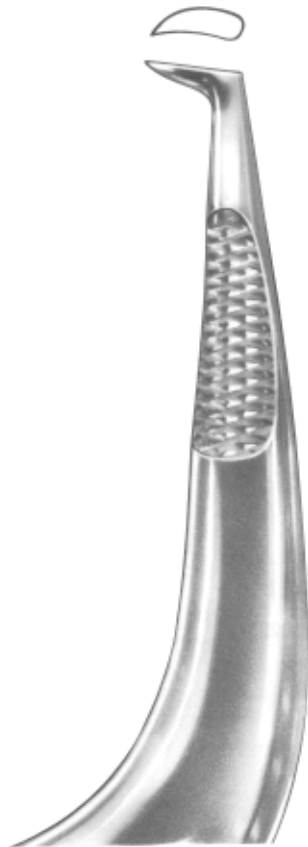

DV-2-3M
Fig2



Mead DV-2-3M
MD1



Mead DV-2-3N
MD-5A



Mead DV-2-3O
MD-6A



Mead DV-2-3P
MD-7A



Mead DV-2-3Q
MD-8

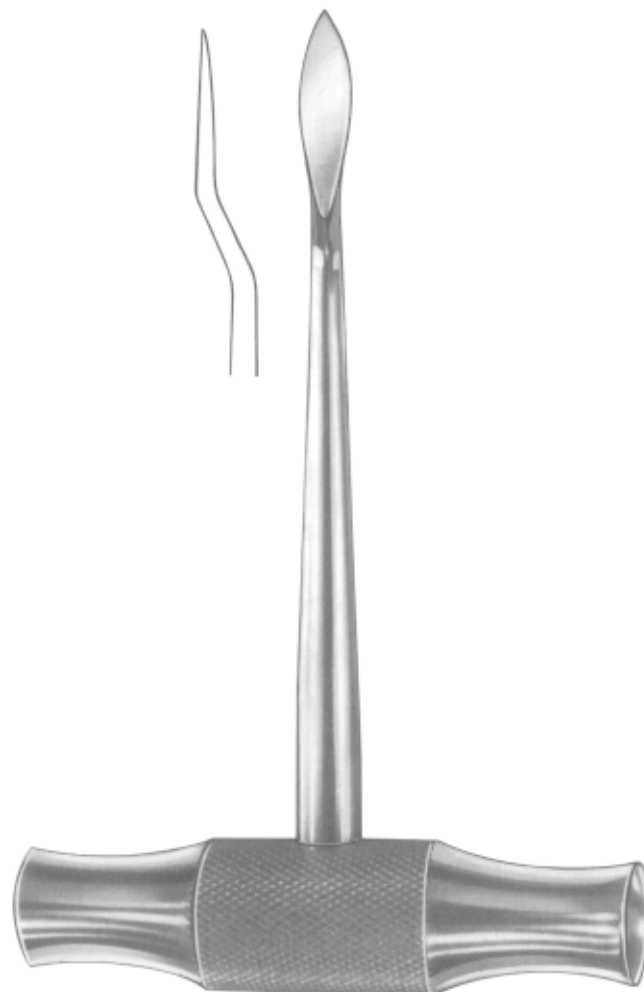

Lecluse DV-2-3R



**Chompret
DV-2-3S
Fig1**



**Chompret
DV-2-3T
Fig2**



**Chompret
DV-2-3U
Fig3**



**Chompret
DV-2-3V
Fig4**

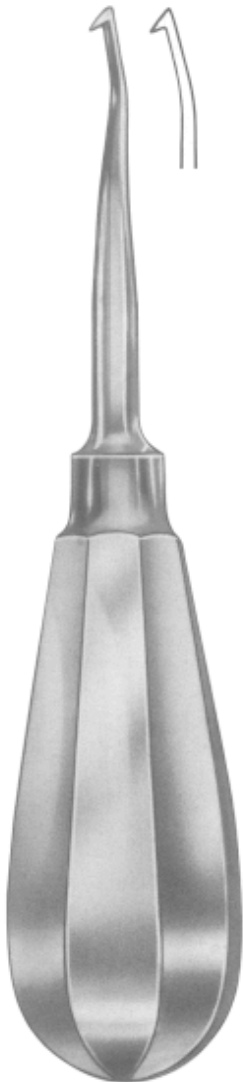

**Apical
DV-2-3X**



DV-2-3Y
Fig1



DV-2-3Z
Fig2



DV-2-4A
Fig3



Heidbrink
DV-2-4B
Fig1



Heidbrink
DV-2-4C
Fig2



Heidbrink
DV-2-4D
Fig3



Winter
DV-2-4E
Fig 1L



Winter
DV-2-4F
Fig 1R



Winter
DV-2-4G
Fig 2L



Winter
DV-2-4H
Fig 2R

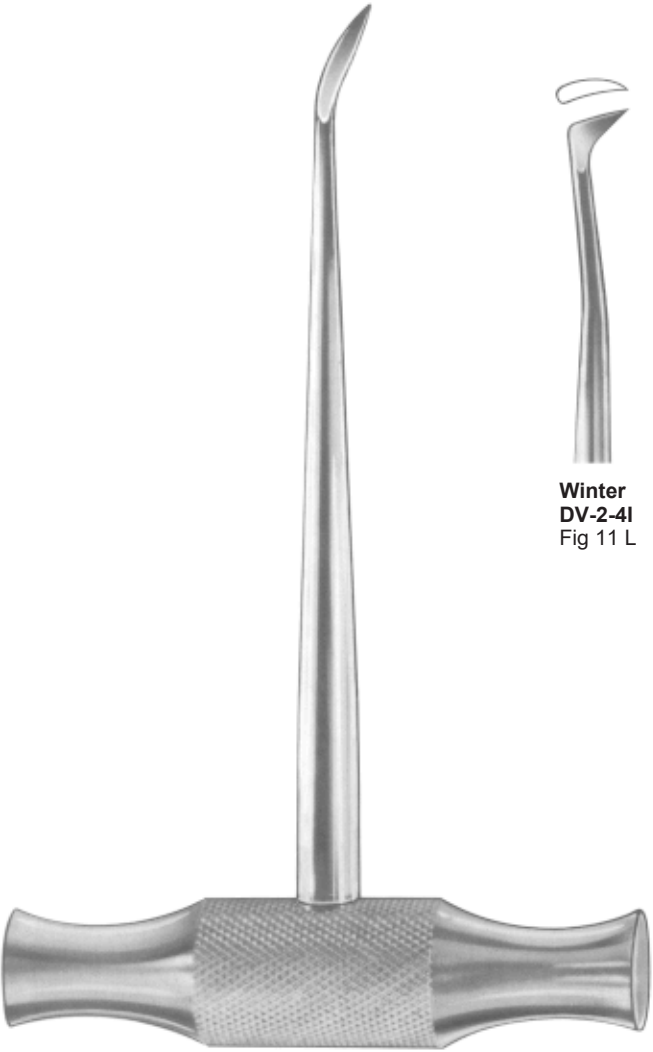

Winter



Winter
DV-2-4I
Fig 11 L



Winter
DV-2-4J
Fig 11 R



Winter
DV-2-4K
Fig 12 L



Winter
DV-2-4L
Fig 12 R



Winter
DV-2-4M
Fig 14 L



Winter
DV-2-4N
Fig 14 R



Barry DV-2-4O
Fig1



Barry DV-2-4P
Fig2



Barry DV-2-4Q
Fig3



Barry DV-2-4R
Fig4



Barry



Barry DV-2-4S
Fig 11



Barry DV-2-4T
Fig 12



Barry DV-2-4U
Fig 17



Barry DV-2-4V
Fig 18



Cryer DV-2-4W
Fig 26



Seldin DV-2-4X
Fig 27



Cryer DV-2-4Y
Fig 28



Cryer DV-2-4Z
Fig 29



Heidbrink DV-2-5A
Fig 22



Heidbrink DV-2-5B
Fig 23



DV-2-5C



Kopp DV-2-5D
Fig 31



Kopp DV-2-5E
Fig 32



Kopp DV-2-5F
Fig 33



Kopp DV-2-5G
Fig 34



Kopp DV-2-5H
Fig 35



Kopp DV-2-5I
Fig 44



DV-2-5J

Root Elevators



**Heidbrink
DV-2-5K
Fig 10**



**Winter
DV-2-5L
Fig 11**



**Winter
DV-2-5M
Fig 12**



**Barry DV-
2-5N
Fig 17**



**Barry DV-
2-5O
Fig 18**



**DV-2-5P
Fig 20**



DV-2-5Q

Root Elevators according to Dr. Sader,
with interchangeable working tips



DV-2-5R



DV-2-5S



DV-2-5T



DENTOVOS

Page
51-55

Filling Instruments

▪

www.dentovos.com

Filling Instruments



DV-3-1A
Williams

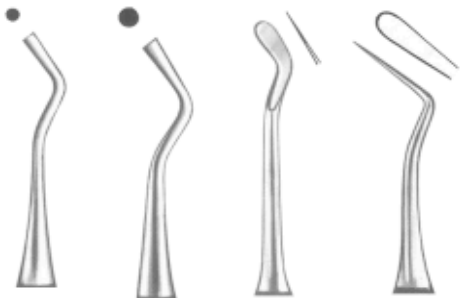

DV-3-1B Williams
DV-3-1C Williams
DV-3-1D Williams
DV-3-1E Williams

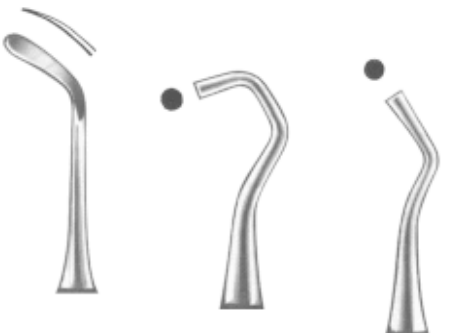
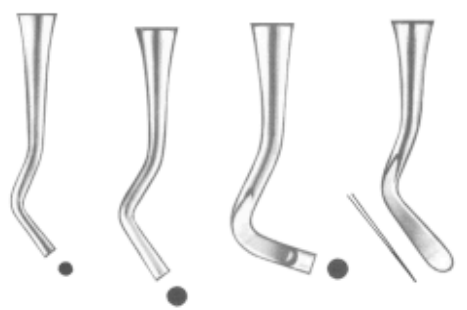

DV-3-1I Williams
DV-3-1J Williams
DV-3-1K Williams



DV-3-1L
White



DV-3-1F White
DV-3-1G White
DV-3-1H White

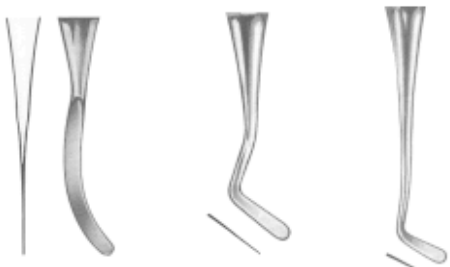

DV-3-1M White
DV-3-1N White
DV-3-1O White



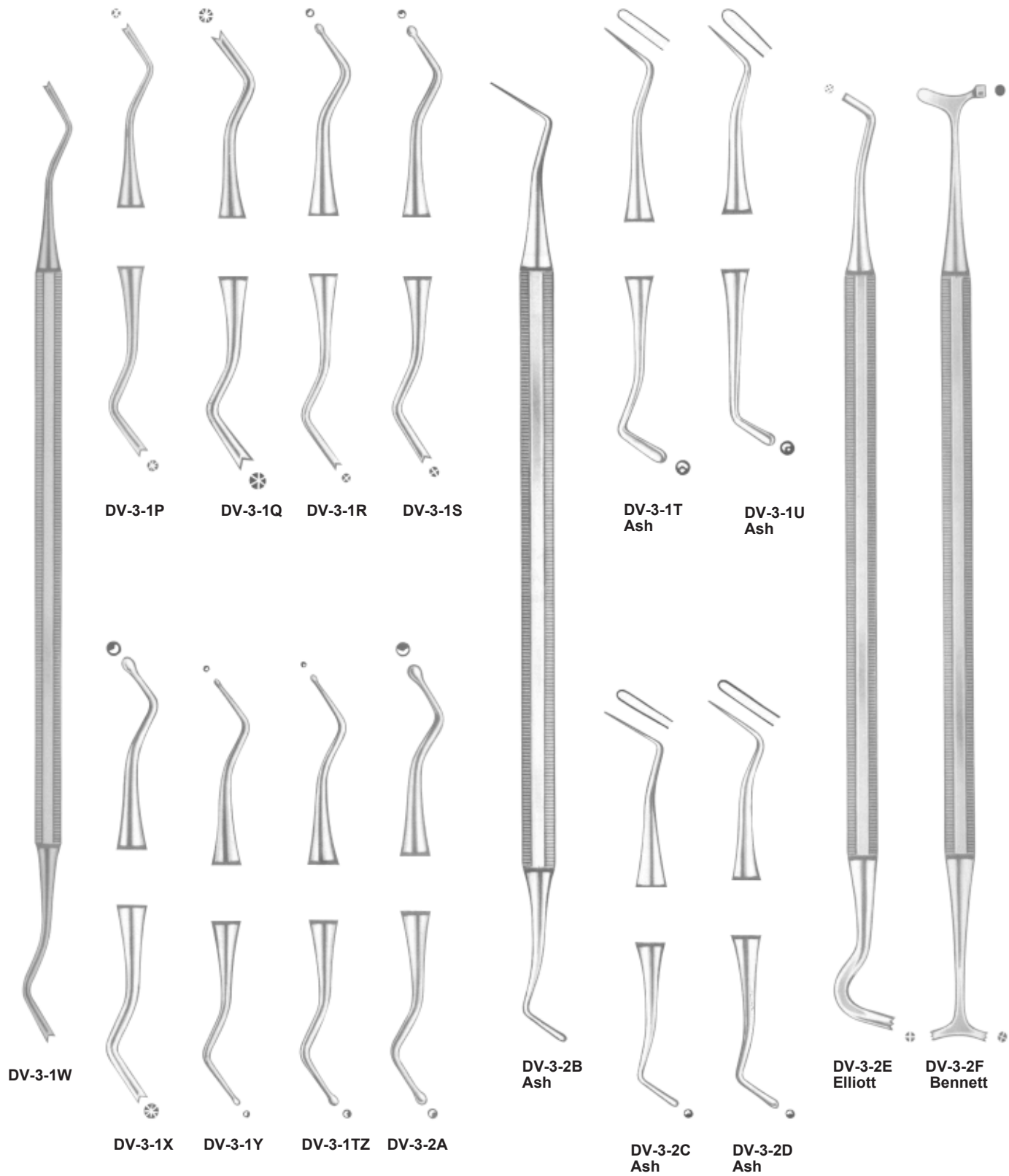

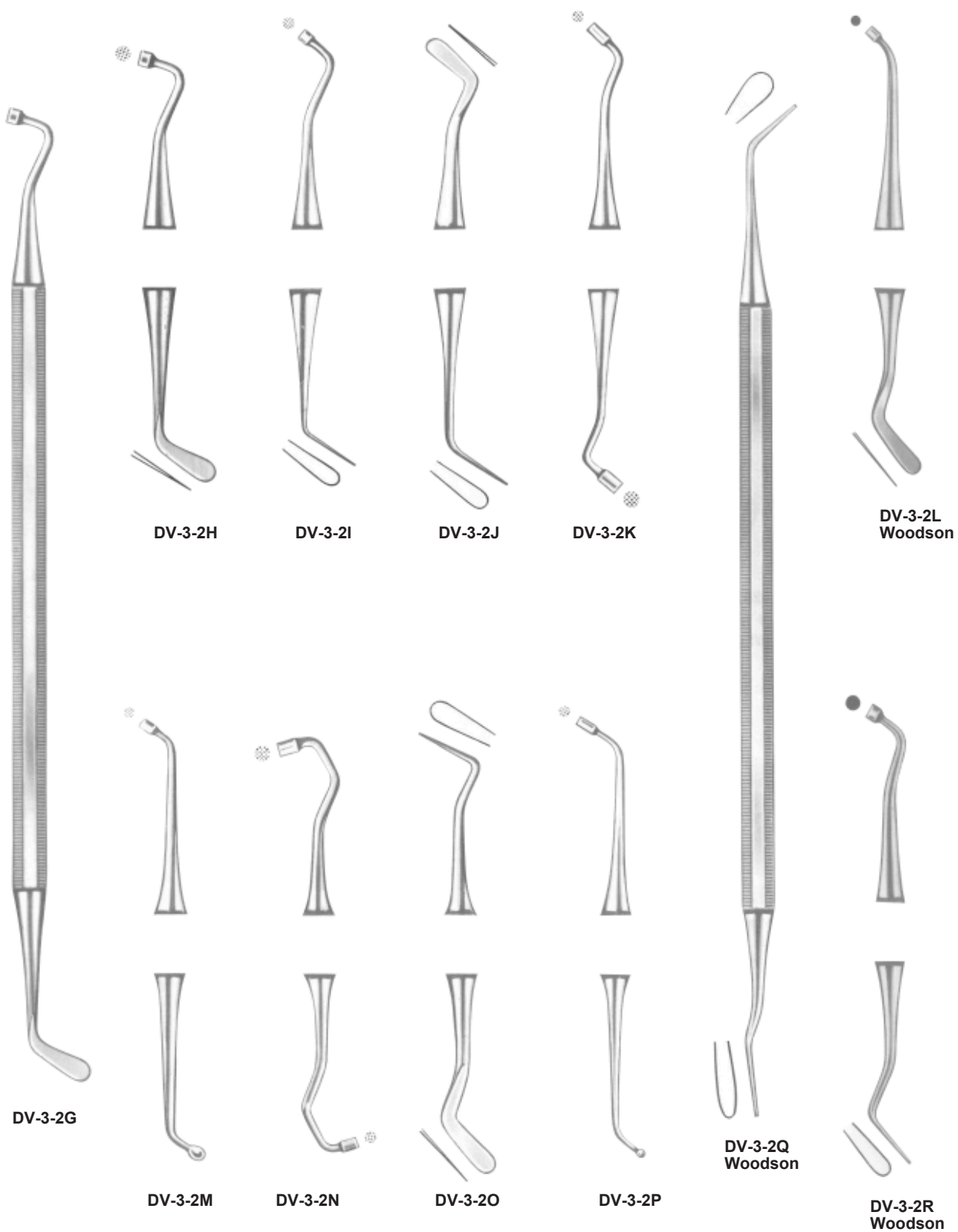

DV-3-2G

DV-3-2H

DV-3-2I

DV-3-2J

DV-3-2K

DV-3-2L
Woodson

DV-3-2M

DV-3-2N

DV-3-2O

DV-3-2P

DV-3-2Q
Woodson

DV-3-2R
Woodson

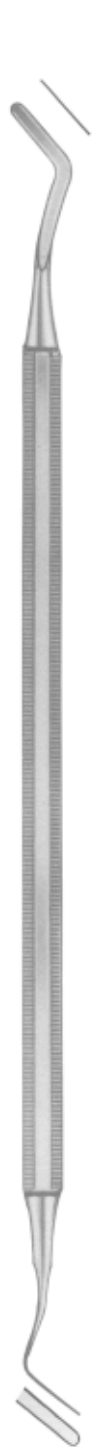

DV-3-2Y
Heidemann
Fig 1



DV-3-2S
Heidemann
Fig 2

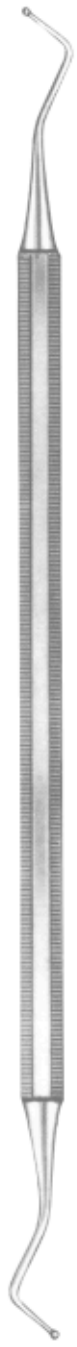

DV-3-3A



DV-3-2Z
Heidemann
Fig 3



DV-3-2U
Fig 146



DV-3-3B
Fig 148



DV-3-2V
Fig 147



DV-3-3C
Fig 149

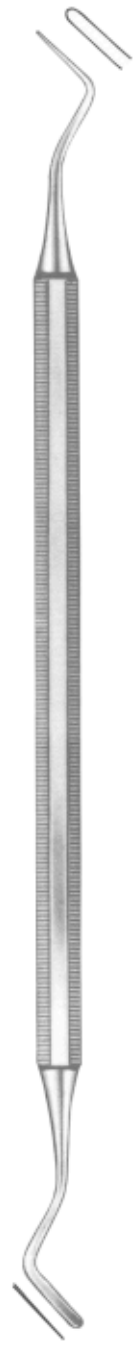

DV-3-3D
Fig 158

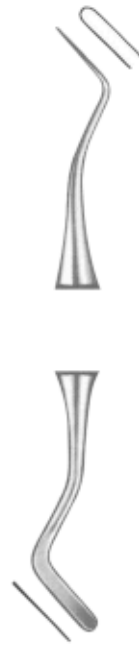

DV-3-2X
Fig 159

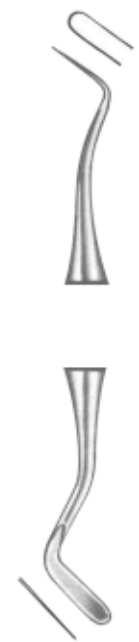

DV-3-3E
Woodson
Fig 160



DV-3-3N
Gracey



DV-3-3F
Gracey
Fig 1



DV-3-3G
Gracey
Fig 2



DV-3-3L
Gracey
Fig 3



DV-3-3M
Gracey
Fig 4



DV-3-3O
Gracey
Fig 5

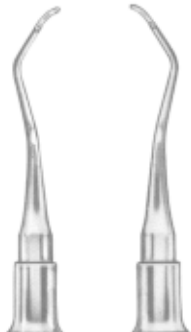

DV-3-3P
Gracey
Fig 6

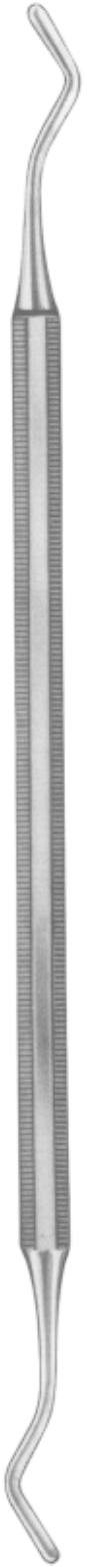

DV-3-3Q



DV-3-3H
Fig 18



DV-3-3I
Fig 19



DV-3-3J
Fig 20



DV-3-3K
Fig 22



DV-3-3R
Fig 23



DV-3-3S
Fig 25



DV-3-3T
Fig 26



DV-3-3U
Fig 27



DENTOVOS

Page
56-59

- Dental Probes

www.dentovos.com

With Point Set In



DV-4-1I



DV-4-1A



DV-4-1B



DV-4-1C



DV-4-1D



DV-4-1E



DV-4-1F



DV-4-1G



DV-4-1H



DV-4-1J



DV-4-1K



DV-4-1L



GDV-4-1M
Woodson

Burnishers and Pocket Probes Scalers

Polishing Instruments

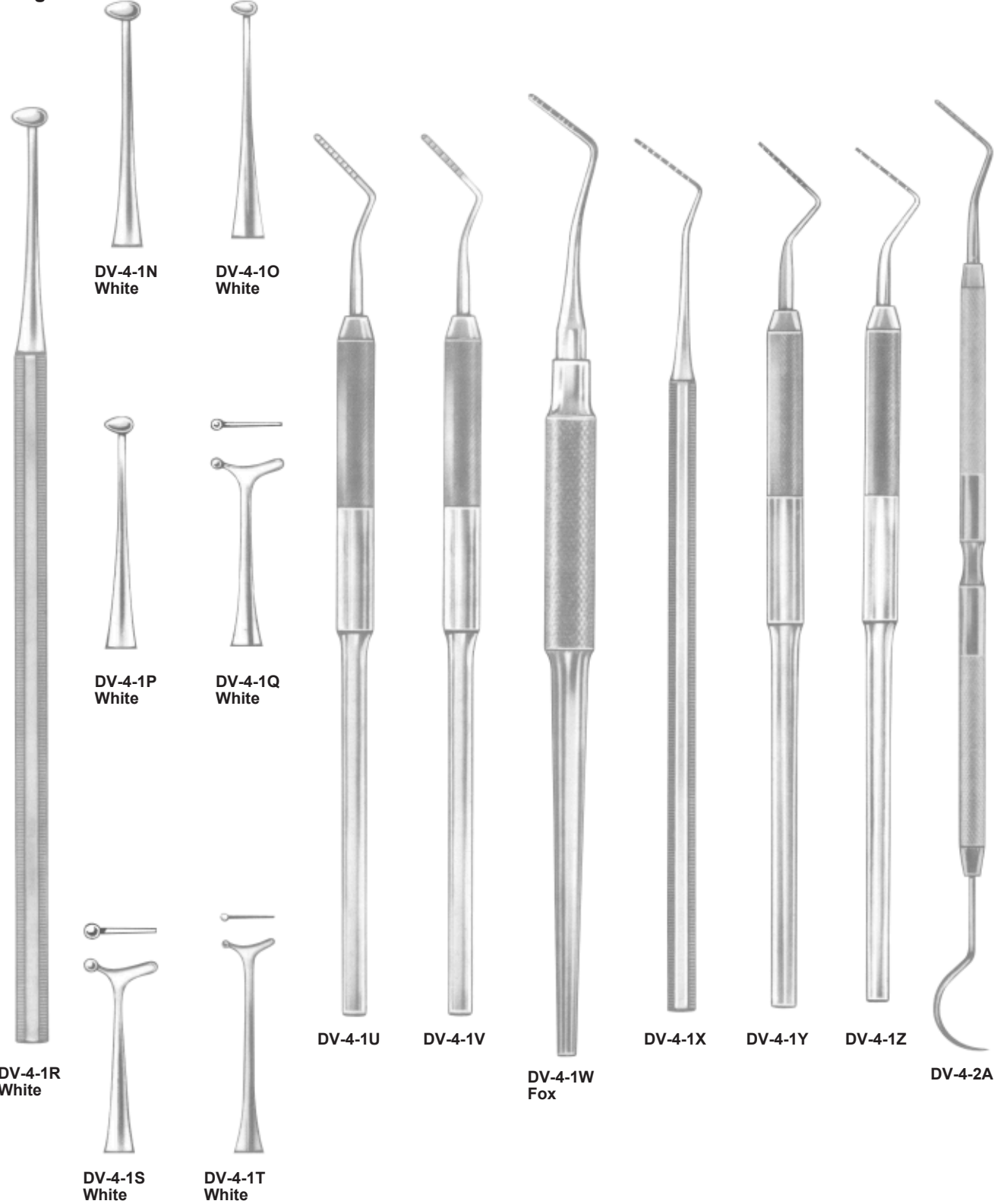



- New marking process.
- Laser system marking.
- No more paint peeling off.
- Permanent marking.
- Antiglare, low depth marking.
- Maximum tip resistance against breaking.



DV-4-2B
FigCP-C



DV-4-2C
Fig CP-11



DV-4-2D
Fig CP-12



DV-4-2E
Fig CP-12S
O.M.S



DV-4-2F
Williams



DV-4-2G
MerritA



DV-4-2H
MerritB



DV-4-2I
Goldman
Fox



DV-4-2J
University of
Michigan



DV-4-2K
26G

The logo for Dentovos, featuring the word "DENTOVOS" in a bold, blue, sans-serif font. A thin, light blue diagonal line crosses through the letter "O" from the top right to the bottom left.

Page
60-67

- Periodontia Instruments, Mallets

www.dentovos.com

Files

Chisels



DV-5-1A
Sugarman
Fig. 1S/2S



DV-5-1B
Sugarman
Fig. 3S/4S



DV-5-1C
Schluger
Fig. 9/10



DV-5-1D
Buck Fig.
11/12



DV-5-1E
Ochsenbein
Fig. 3



DV-5-1F
Ochsenbein
Fig. 4



DV-5-1G
Rhodes Back
- Action Fig.
36/37

Files

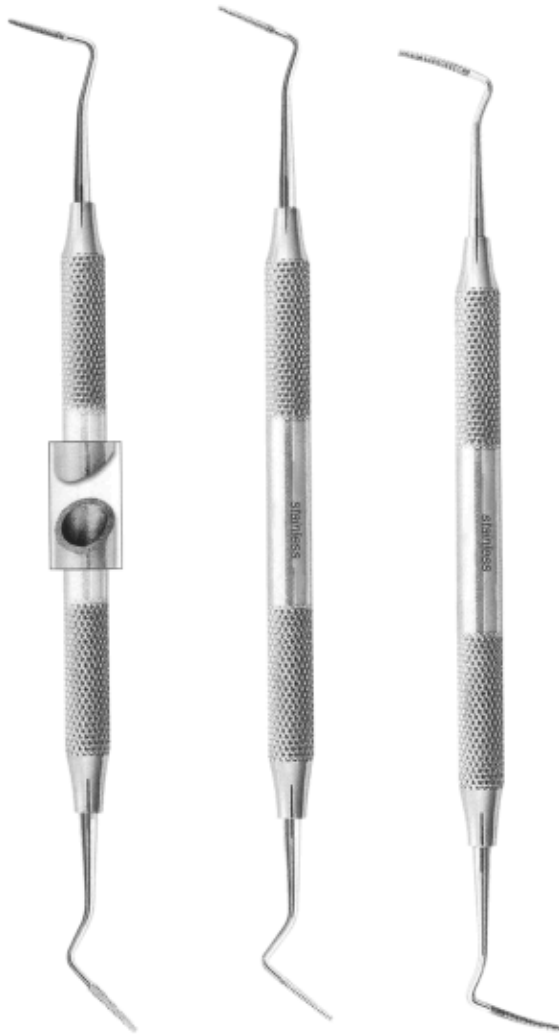

DV-5-1H
Sugarman
Fig. 1S/2S

DV-5-1I
Sugarman
Fig. 3S/4S

DV-5-1J
Schluger
Fig. 9/10



DV-5-1K
Buck Fig.
11/12



Chisels



DV-5-1L
Ochsenbein
Fig. 3



DV-5-1M
Ochsenbein
Fig. 4



DV-5-1N
Rhodes Back
- Action Fig.
36/37

Gingivectomy knives



DV-5-10
Goldman-Fox
Fig. 7



DV-5-1P
Goldman-Fox
Fig. 8



DV-5-1Q
Goldman-Fox
Fig. 9



DV-5-1R
Goldman-Fox
Fig. 11



DV-5-1S
Buck Fig.
3/4



DV-5-1T
Buck Fig.
5/6

Curettes and Scalers



DV-5-1U
Curette
Fig. HU 1/2



DV-5-1V
Columbia
Fig. 2R/2L



DV-5-1X
Columbia
Fig. 4R/4L



DV-5-1Y
Columbia
Fig. 13/14



DV-5-1Z
Fig. 411/412



DV-5-2A
Fig. 413/414



DV-5-2B
Zerfing-chisel

Gingivectomy knives



DV-5-2C
Goldman - Fox
Fig. 7



DV-5-2D
Goldman - Fox
Fig. 8



DV-5-2E
Goldman - Fox
Fig. 9



DV-5-2F
Goldman - Fox
Fig. 11



DV-5-2G
Buck Fig.
3/4



DV-5-2H
Buck Fig.
5/6

Curettes and Scalers



DV-5-2I
Curette
Fig. HU 1/2



DV-5-2J
Columbia
Fig. 2R/2L



DV-5-2K
Columbia
Fig. 4R/4L



DV-5-2L
Columbia
Fig. 13/14



DV-5-2M
Fig. 413/412



DV-5-2N
Fig. 411/414



DV-5-20
Zerfing-chisel

Bone Chisels and Gouges

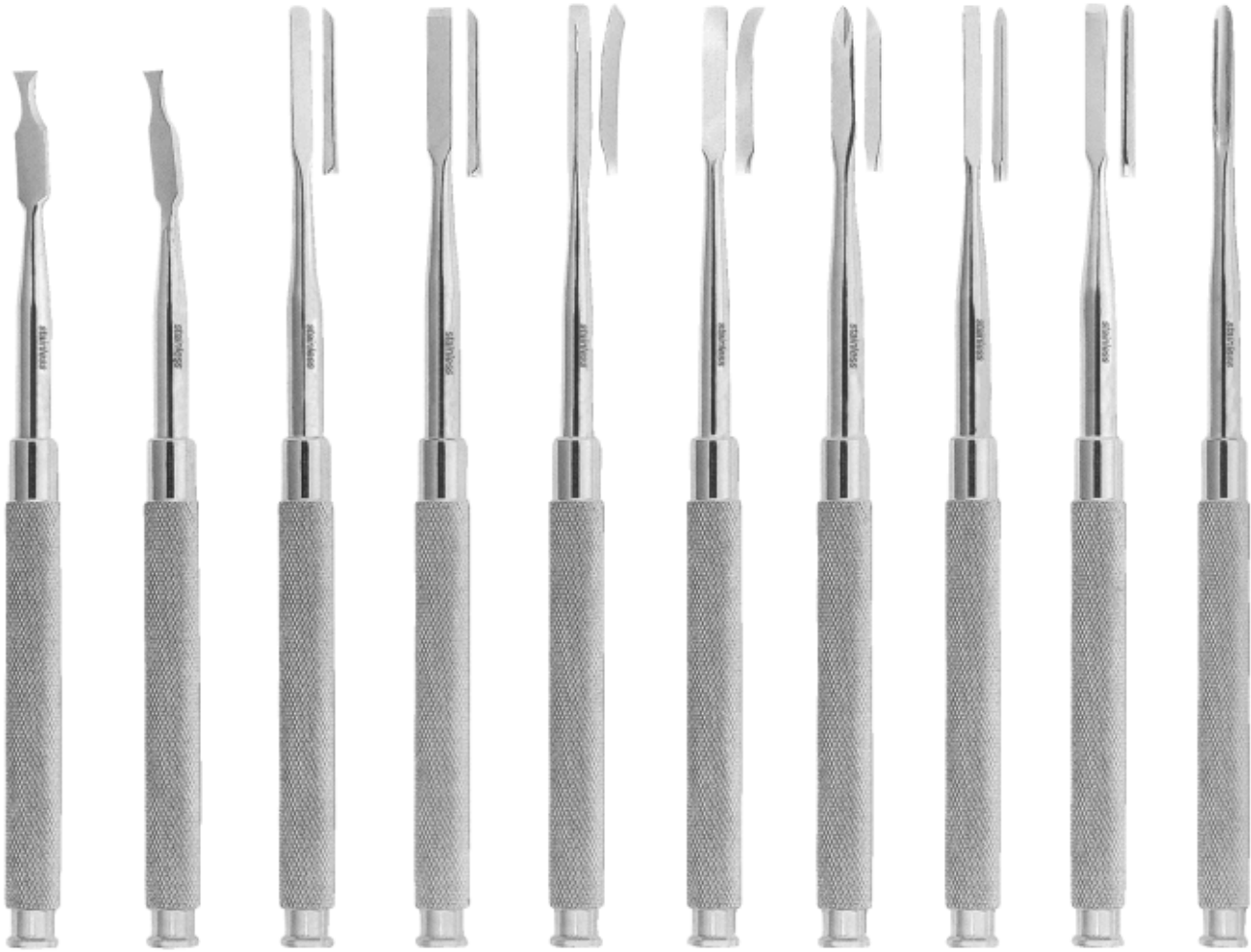

DV-5-2P
Ochsenbein
Fig. 1

DV-5-2Q
Ochsenbein
Fig. 2

DV-5-2R
Gardner
Fig. 1

DV-5-2S
Gardner
Fig. 2

DV-5-2T
Gardner
Fig. 5

DV-5-2U
Gardner
Fig. 5R

DV-5-2V
Gardner
Fig. 6

DV-5-2X
Wakefield
Fig. 1W

DV-5-2X
Wakefield
Fig. 2W

DV-5-2Z
Buckley
Fig. 3

Bone Chisels and Gouges

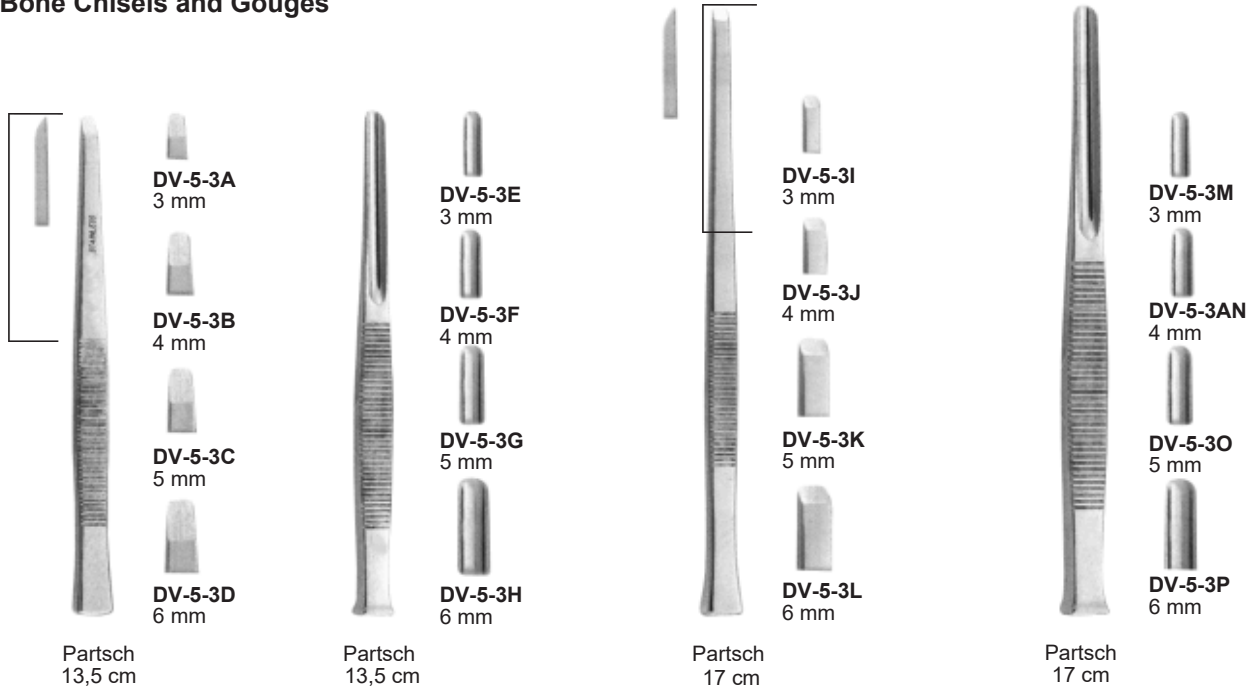

Martelli chirurgici Mallet

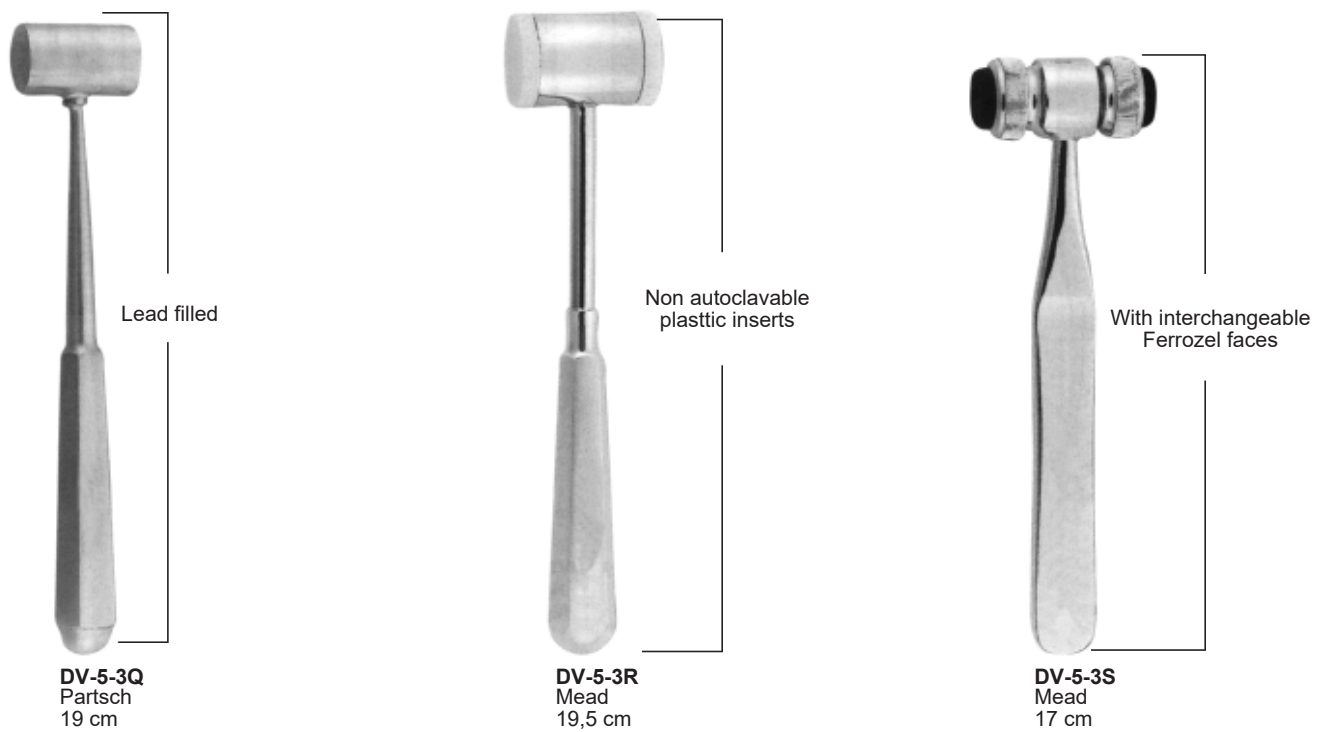



Page
68-74

- Currettes Scalers

www.dentovos.com

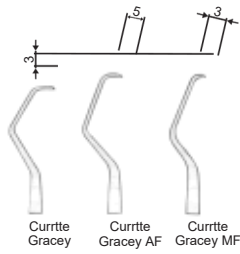

DV-6-1A
Gracey
Fig. 1/2



DV-6-1B
Gracey
Fig. 3/4



DV-6-1C
Gracey
Fig. 5/6



DV-6-1D
Gracey
Fig. 7/8



DV-6-1E
Gracey
Fig. 9/10



DV-6-1F
Gracey
Fig. 11/12



DV-6-1G
Gracey
Fig. 13/14



DV-6-1H
Gracey
Mesial Distal
Fig. 11/14



DV-6-1I
Gracey
Mesial Distal
Fig. 12/13

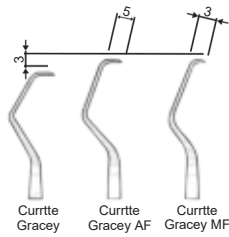

DV-6-1J
Gracey
AF/type
Fig. 1/2



DV-6-1K
Gracey
AF/type
Fig. 3/4



DV-6-1L
Gracey
AF/type
Fig. 5/6



DV-6-1M
Gracey
AF/type
Fig. 7/8



DV-6-1N
Gracey
AF/type
Fig. 11/12



DV-6-1O
Gracey
AF/type
Fig. 13/14



DV-6-1P
Gracey
AF/type
Fig. 15/16



DV-6-1Y
Gracey
AF/type



DV-6-1Q
Gracey
AF/type
Fig. 1/2



DV-6-1R
Gracey
AF/type
Fig. 3/4



DV-6-1S
Gracey
AF/type
Fig. 5/6



DV-6-1T
Gracey
AF/type
Fig. 7/8



DV-6-1U
Gracey
AF/type
Fig. 11/12



DV-6-1V
Gracey
AF/type
Fig. 13/14



DV-6-1X
Gracey
AF/type
Fig. 15/16



DV-6-1Z
Gracey
MF/type
Fig. 1/2



DV-6-2A
Gracey
MF/type
Fig. 3/4



DV-6-2B
Gracey
MF/type
Fig. 5/6



DV-6-2C
Gracey
MF/type
Fig. 7/8



DV-6-2D
Gracey
MF/type
Fig. 11/12



DV-6-2E
Gracey
MF/type
Fig. 13/14



DV-6-2F
Gracey
MF/type
Fig. 15/16

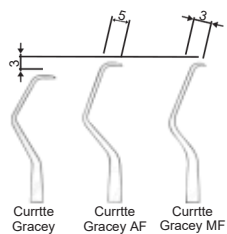

DV-6-2G
Gracey
MF/type
Fig. 1/2



DV-6-2H
Gracey
MF/type
Fig. 3/4



DV-6-2I
Gracey
MF/type
Fig. 5/6



DV-6-2J
Gracey
MF/type
Fig. 7/8



DV-6-2K
Gracey
MF/type
Fig. 11/12



DV-6-2L
Gracey
MF/type
Fig. 13/14



DV-6-2M
Gracey
MF/type
Fig. 15/16



DV-6-2Q
Goldman - Fax
Fig. 1



DV-6-2N
Goldman - Fax
Fig. 2



DV-6-2O
Goldman - Fax
Fig. 3



DV-6-2P
Goldman - Fax
Fig. 4



DV-6-2R
Goldman - Fax
Fig. 21

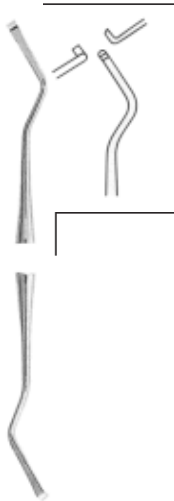

DV-6-2S
Goldman - Fax
Fig. 5



DV-6-2T
Mc Call Fig.
13S/14S

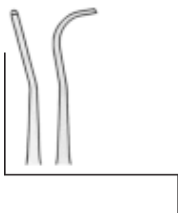

DV-6-2U
Younger-Good
Fig. 7/8

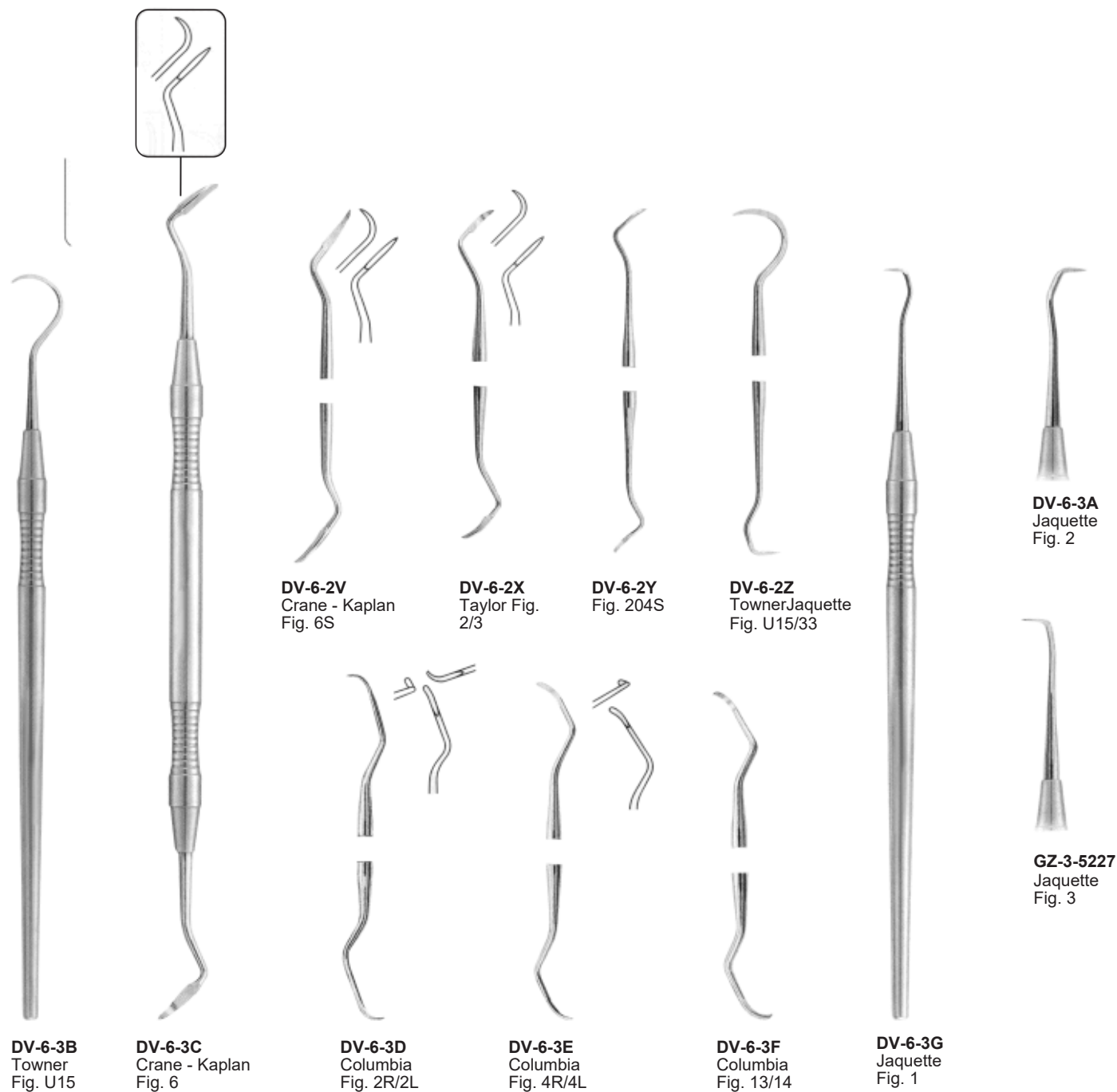

DV-6-3B
Towner
Fig. U15

DV-6-3C
Crane - Kaplan
Fig. 6

DV-6-2V
Crane - Kaplan
Fig. 6S

DV-6-2X
Taylor Fig.
2/3

DV-6-2Y
Fig. 204S

DV-6-2Z
TownerJaquette
Fig. U15/33

DV-6-3A
Jaquette
Fig. 2

DV-6-3D
Columbia
Fig. 2R/2L

DV-6-3E
Columbia
Fig. 4R/4L

DV-6-3F
Columbia
Fig. 13/14

DV-6-3G
Jaquette
Fig. 1

GZ-3-5227
Jaquette
Fig. 3



DV-6-3H
Hemingway
Fig. 1



DV-6-3I
Hemingway
Fig. 2



DV-6-3J
Hemingway
Fig. 3



DV-6-3K
Lucas Fig.
85



DV-6-3L
Lucas Fig.
86



DV-6-3M
Lucas Fig.
87

The logo for Dentovos, featuring the word "DENTOVOS" in a bold, blue, sans-serif font. A thin, light blue diagonal line crosses through the letter "O" from the top-left to the bottom-right.

Page
75-77

- Modelling Instruments & Measuring Instruments

www.dentovos.com

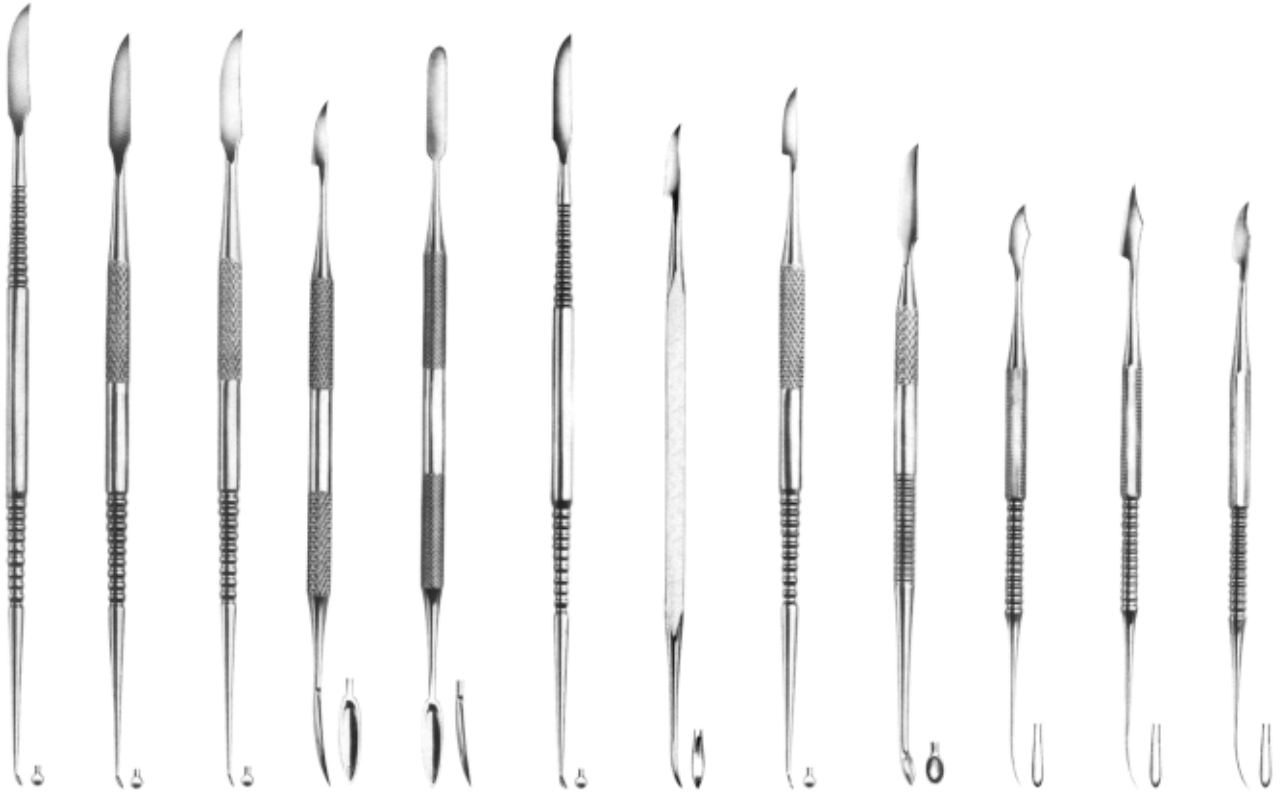

DV-7-1A
Le Cron

DV-7-1B
Le Cron

DV-7-1C
Le Cron

DV-7-1D
MSY

DV-7-1E
MSY

DV-7-1F
Le Cron

DV-7-1G
Hylin

DV-7-1H
Hylin

DV-7-1I
Hylin

DV-7-1J
Zahle

DV-7-1K
Zahle

DV-7-1L
Zahle

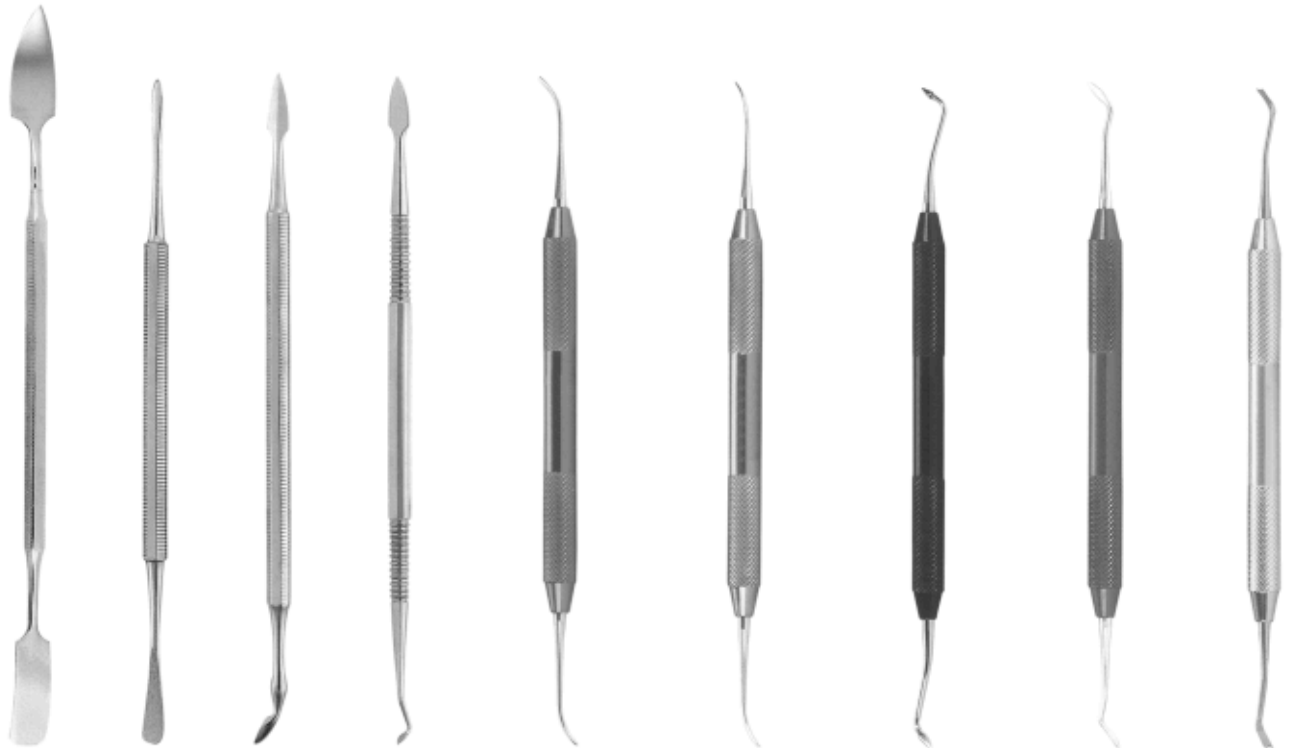

DV-7-1M
Gritman

DV-7-1N
Beale

DV-7-1O
Roach

DV-7-1P
Vehe

DV-7-1Q
P.K.
Thomas Fig.
1

DV-7-1R
P.K.
Thomas Fig.
2

DV-7-1S
P.K.
Thomas Fig.
3

DV-7-1T
P.K.
Thomas Fig.
4

DV-7-1U
P.K.
Thomas Fig.
5



DV-7-1V
Boley



DV-7-1X
Zuricher
130 mm



DV-7-1Y
Vernier 12
cm



DV-7-1Z
Vernier

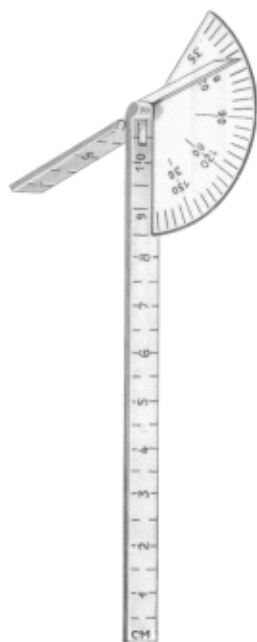

DV-7-2A
Carroll



DV-7-2B
Castroviejo's
Scleral Marker



DV-7-2C
Iwanson

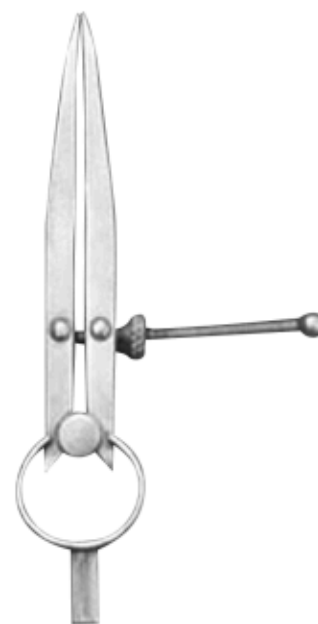

DV-7-2D
Albee



DV-7-2E
18cm
7 1/8"



DV-7-2F
18cm
7 1/8"



DV-7-2G
17 cm 6
3/4 "
Gritman



DV-7-2H
17 cm 6
3/4 "
Medicon



DV-7-2I
22 cm 8
3/4"



DV-7-2J
Antkoviak



DV-7-2K
Ermert



DV-7-2L
Ermert

DENTOVOS

Page
78-79

▪ Wax Knives/plaster

www.dentovos.com



DV-8-1A
Fahnenstock
Fig. 1
12,5cm



DV-8-1B
Fahnenstock
Fig. 2 17cm



DV-8-1C
Lessmann
Fig. 1
12,5cm



DV-8-1D
Lessmann
Fig. 2
17cm



DV-8-1E
Con scodellino
Fig. 1 12,5cm



DV-8-1F
Con scodellino
Fig. 2 17cm

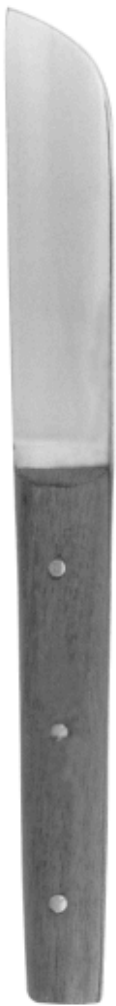

DV-8-1G
Fig, 1 17
cm



DV-8-1H
Gritman
Fig, 2 17
cm

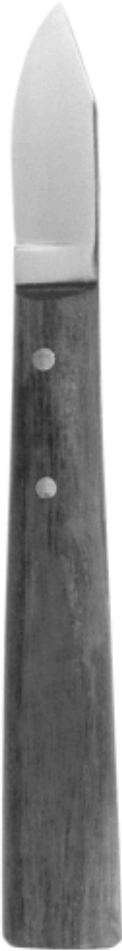

DV-8-1I
Fig, 3 16
cm



DV-8-1J
Fig, 4 16
cm



Page 80-85

- Diagnostic, Explorer, Endodontic Instruments

www.dentovos.com

Explorers



DV-9-1A
Fig 23



DV-9-1B
Fig6



DV-9-1C
Fig8



DV-9-1D
Fig9



DV-9-1E
Fig 17



DV-9-1F
Fig 3 Rein



DV-9-1G
Fig 23/17



DV-9-1H
Fig 17

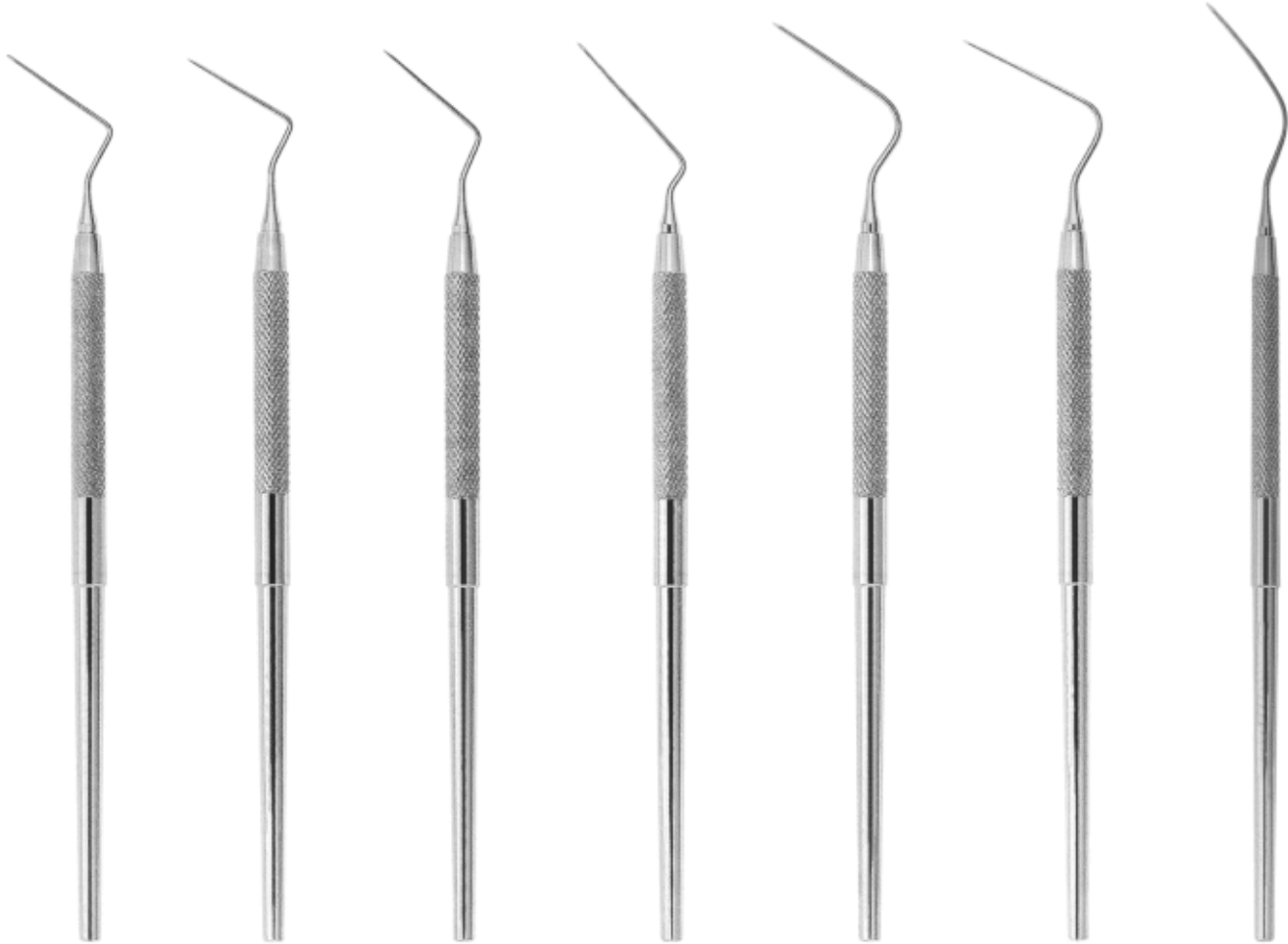

DV-9-1I
Fig.1
Spreader

DV-9-1J
Fig.2
Spreader

DV-9-1K
Fig.3
Spreader

DV-9-1L
Fig.4
Spreader

DV-9-1M
Fig.5
Spreader

DV-9-1N
Fig.6
Spreader

DV-9-1O
Fig.7
Spreader

Double-Ended Root Canal Explorers Plugger/Spreaders

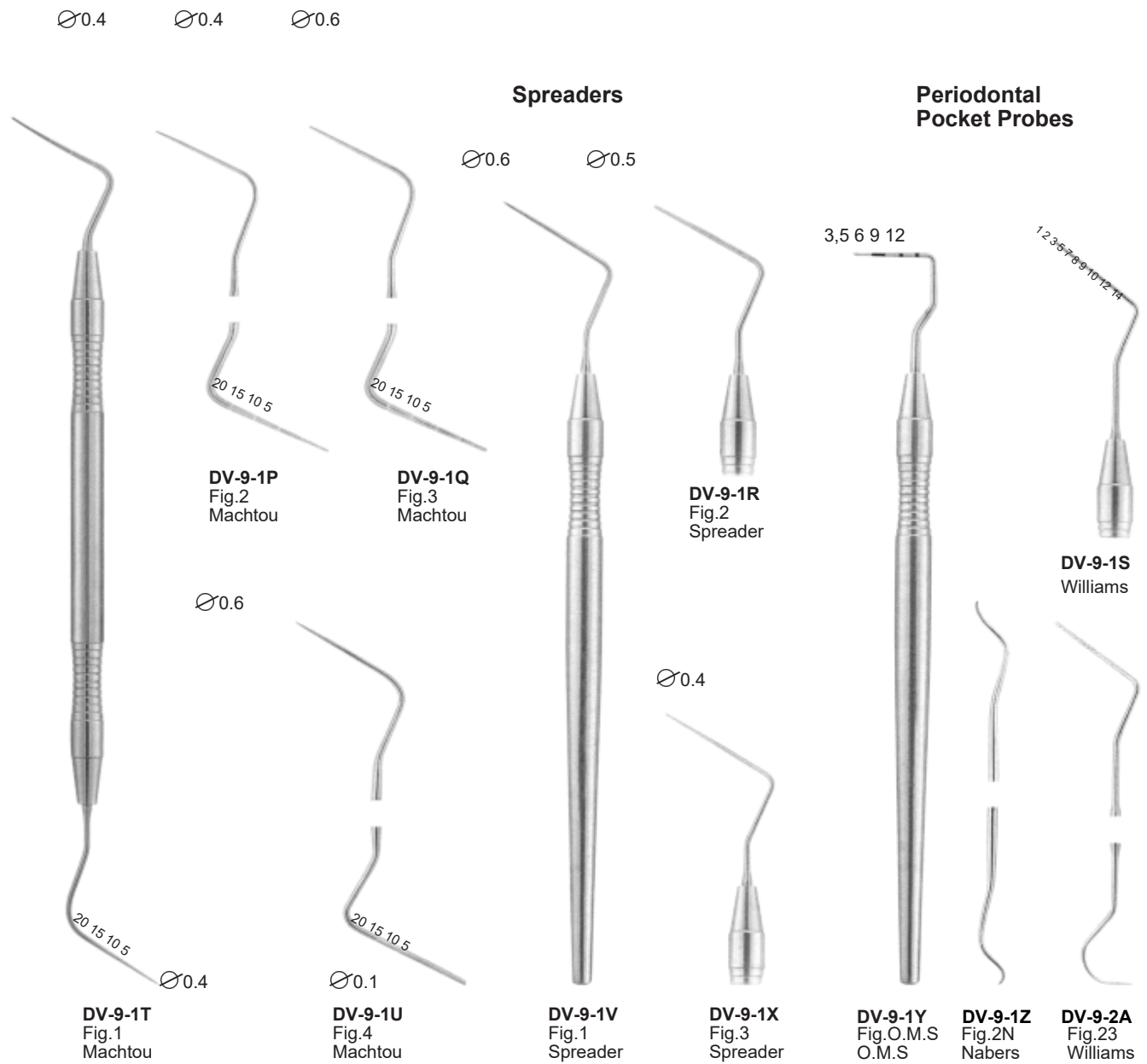

Root-canal pluggers

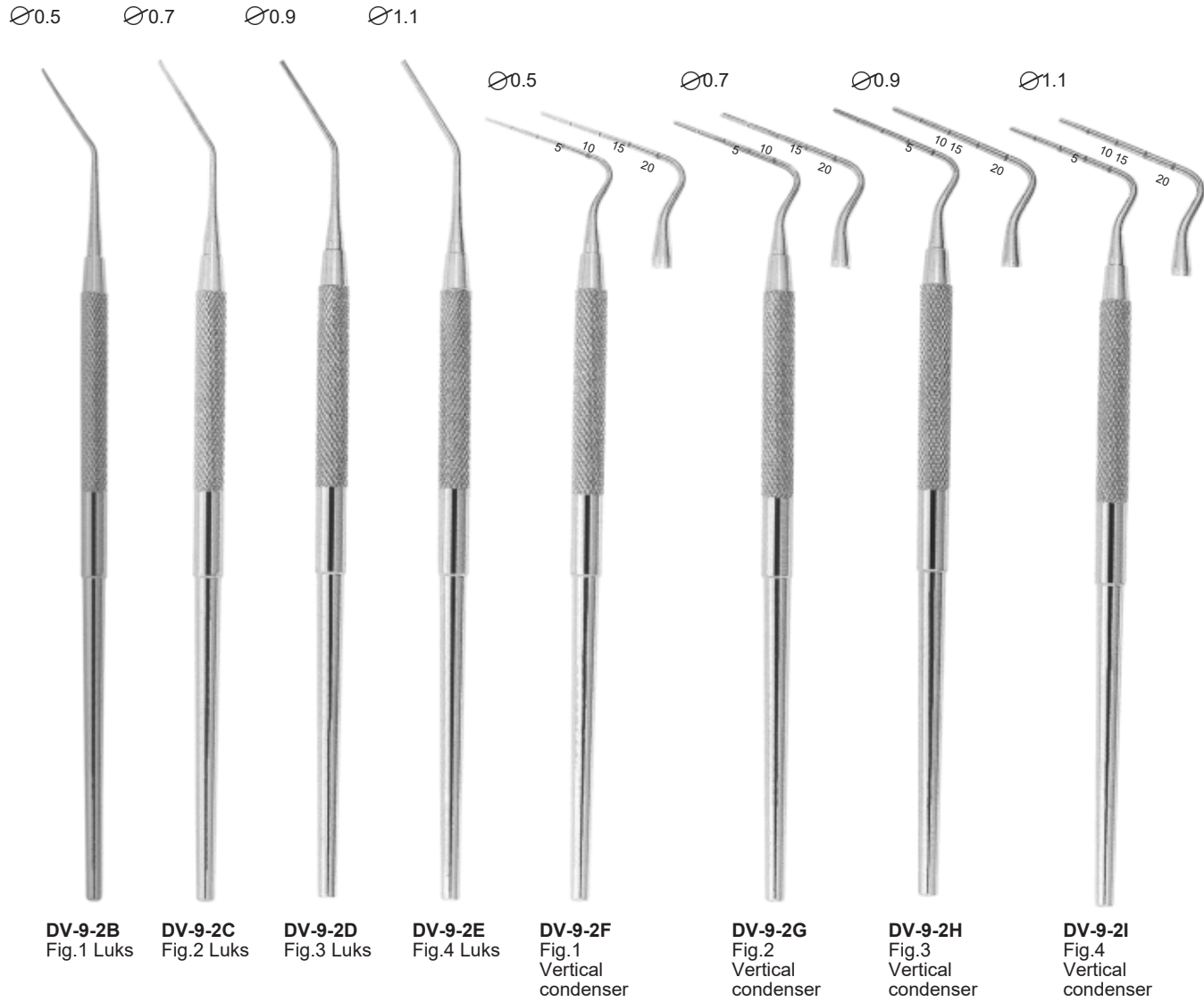

Endodontic set

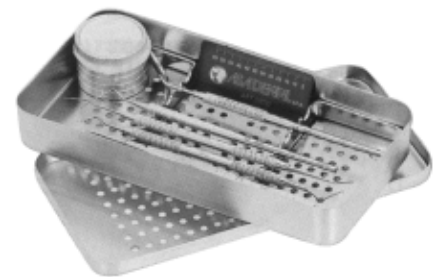

DV-9-2J
Measuring Plate

Root-canal pluggers

Optimum Flexibility
Very Fine Points

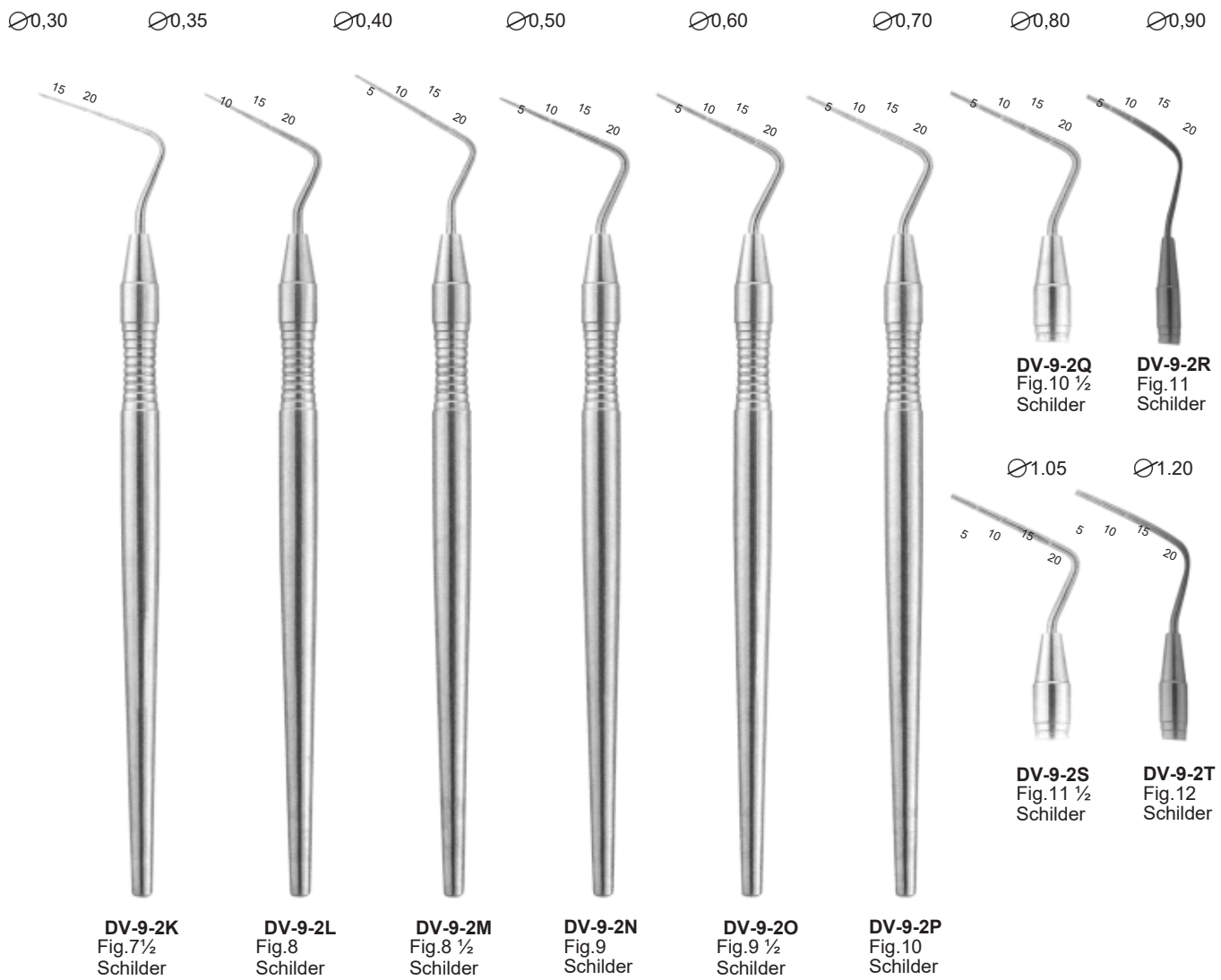

Root-canal explorers

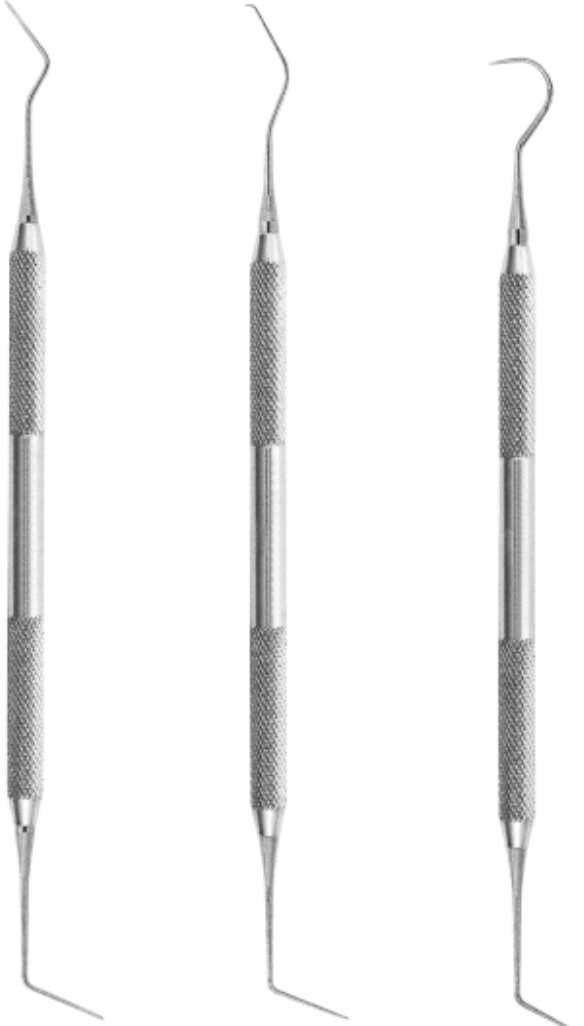

DV-9-2U
Fig.6/1

DV-9-2V
Fig.6/17

DV-9-2W
Fig.6/23

Root-canal excavators



DV-9-2X
Fig.31L

DV-9-2Y
Fig.32L

DV-9-2Z
Fig.33L

DENTOVOS

Page
86-87

- Excavators

www.dentovos.com

1 mm



DV-10-1A
Fig5

1.2 mm



DV-10-1B
Fig 14

1 mm



DV-10-1C
Fig 17

1.2 mm



DV-10-1D
Fig 18

1.6 mm



DV-10-1E
Fig 19

2 mm



DV-10-1F
Fig 20

1 mm



DV-10-1L
ASH
Fig.243

1,4 mm



DV-10-1M
ASH
Fig.G2

0,8 mm



DV-10-1G
Fig.1

0,8 mm



DV-10-1H
Fig.2

1 mm



DV-10-1I
Fig.11

1 mm



DV-10-1J
Fig.12

1,2 mm



DV-10-1K
Fig.21

1,2 mm



DV-10-1N
Fig.22

1,6 mm



DV-10-1O
Fig.31

1,6 mm



DV-10-1P
Fig.32

2 mm



DV-10-1Q
Fig.41

2 mm



DV-10-1R
Fig.42

The logo for Dentovos, featuring the word "DENTOVOS" in a bold, blue, sans-serif font. A thin, light blue diagonal line crosses through the letter "O" from the top-left to the bottom-right.

Page
88-89

- Handles For Mouth Mirrors

www.dentovos.com

Handles for Mouth Mirrors and Mouth Mirrors

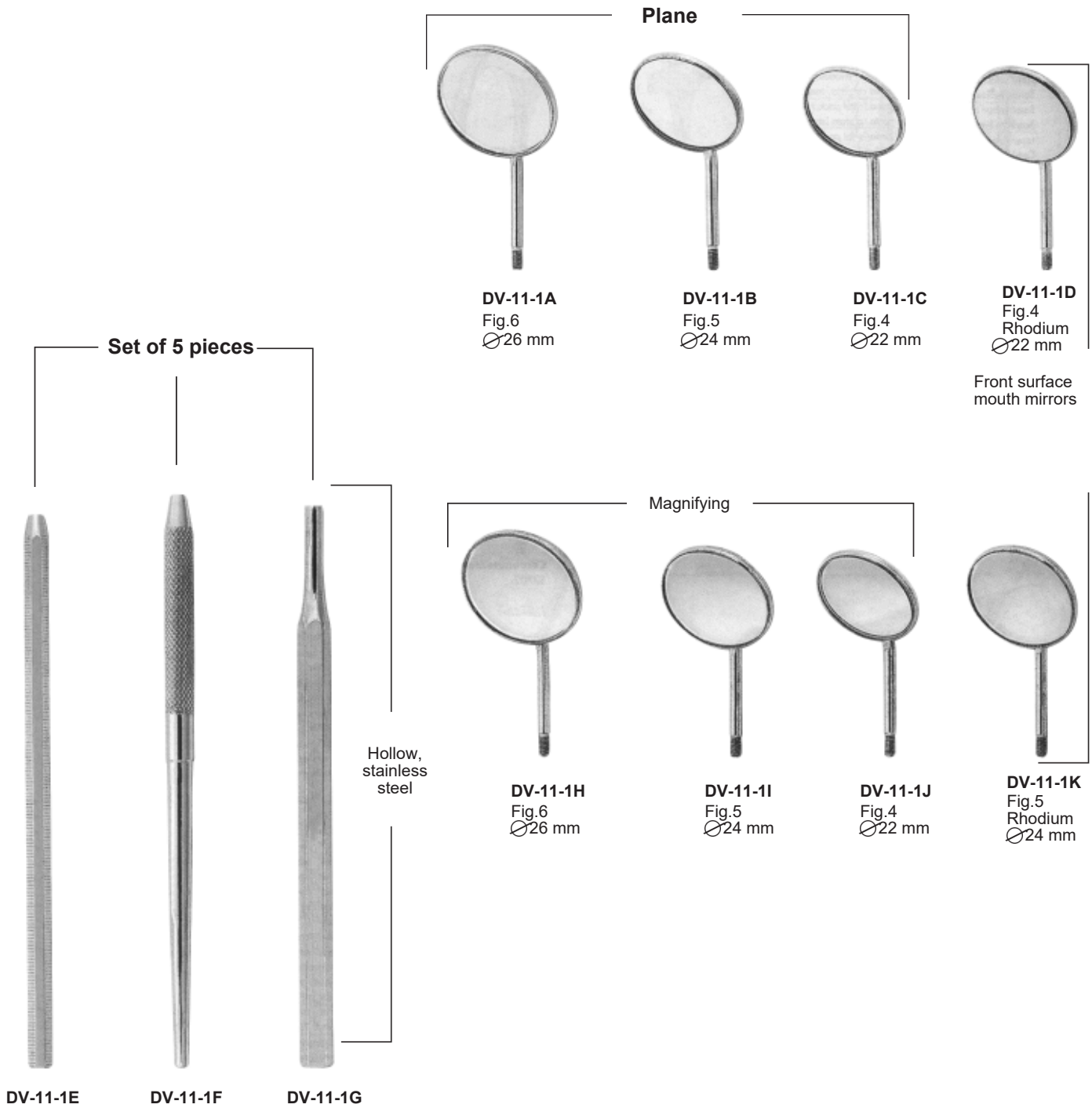

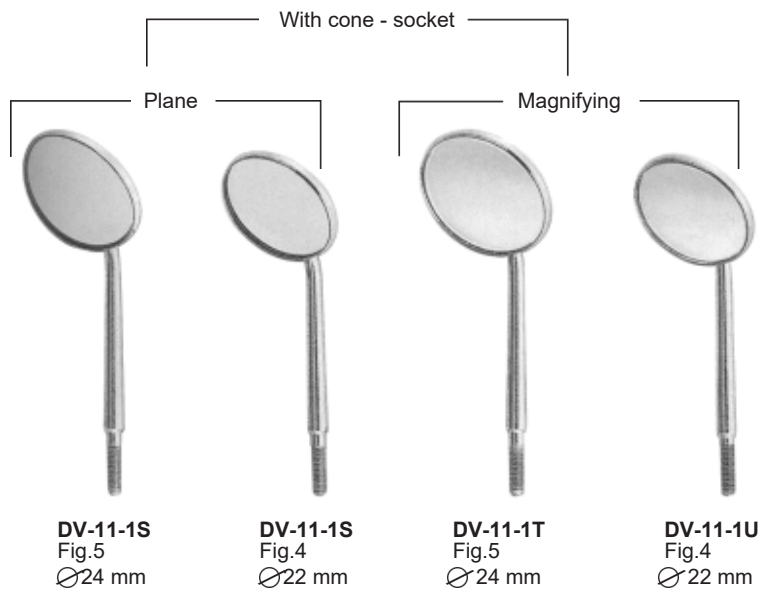
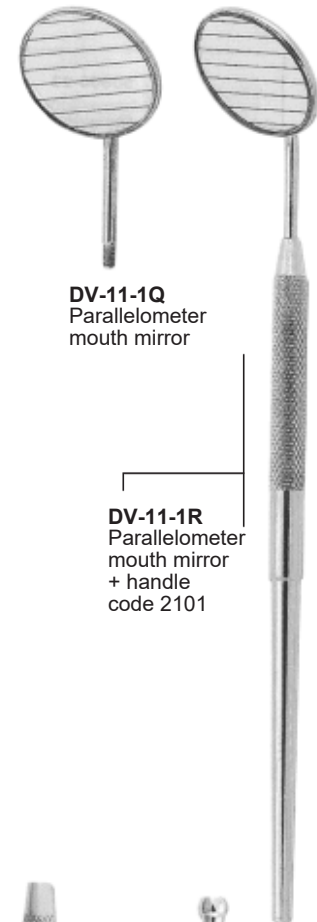
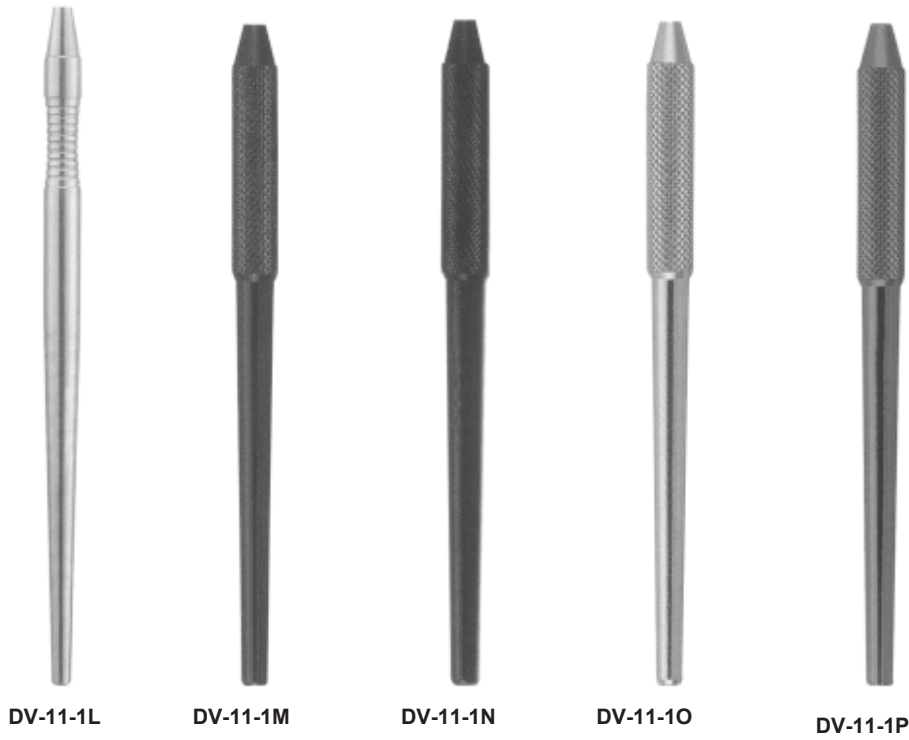

DENTOVOS

Page
90-93

- Spatulas

www.dentovos.com

Cement Spatulas



DV-12-1A



DV-12-1B



DV-12-1C



DV-12-1D



DV-12-1E



DV-12-1F



DV-12-1G



DV-12-1H

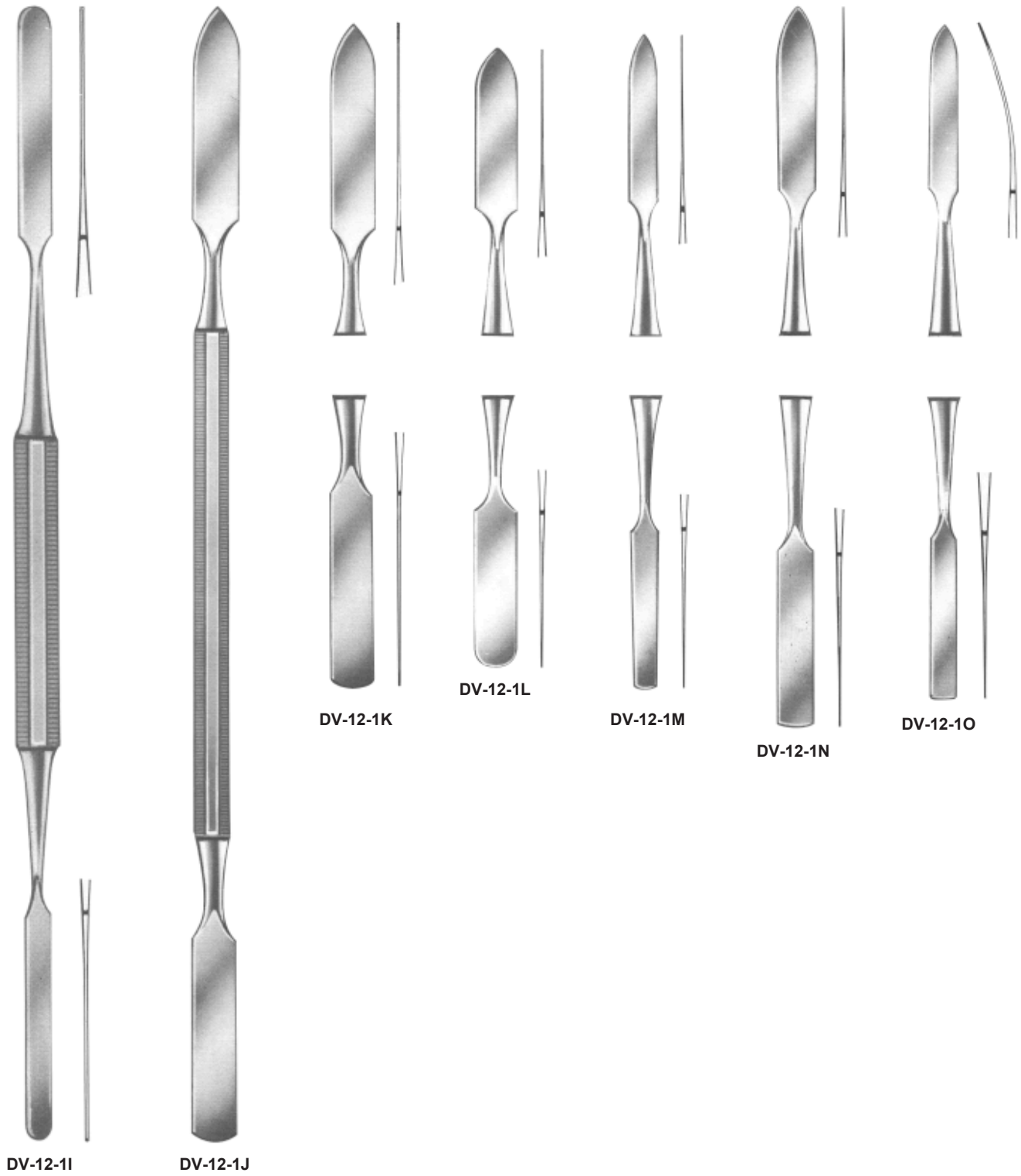



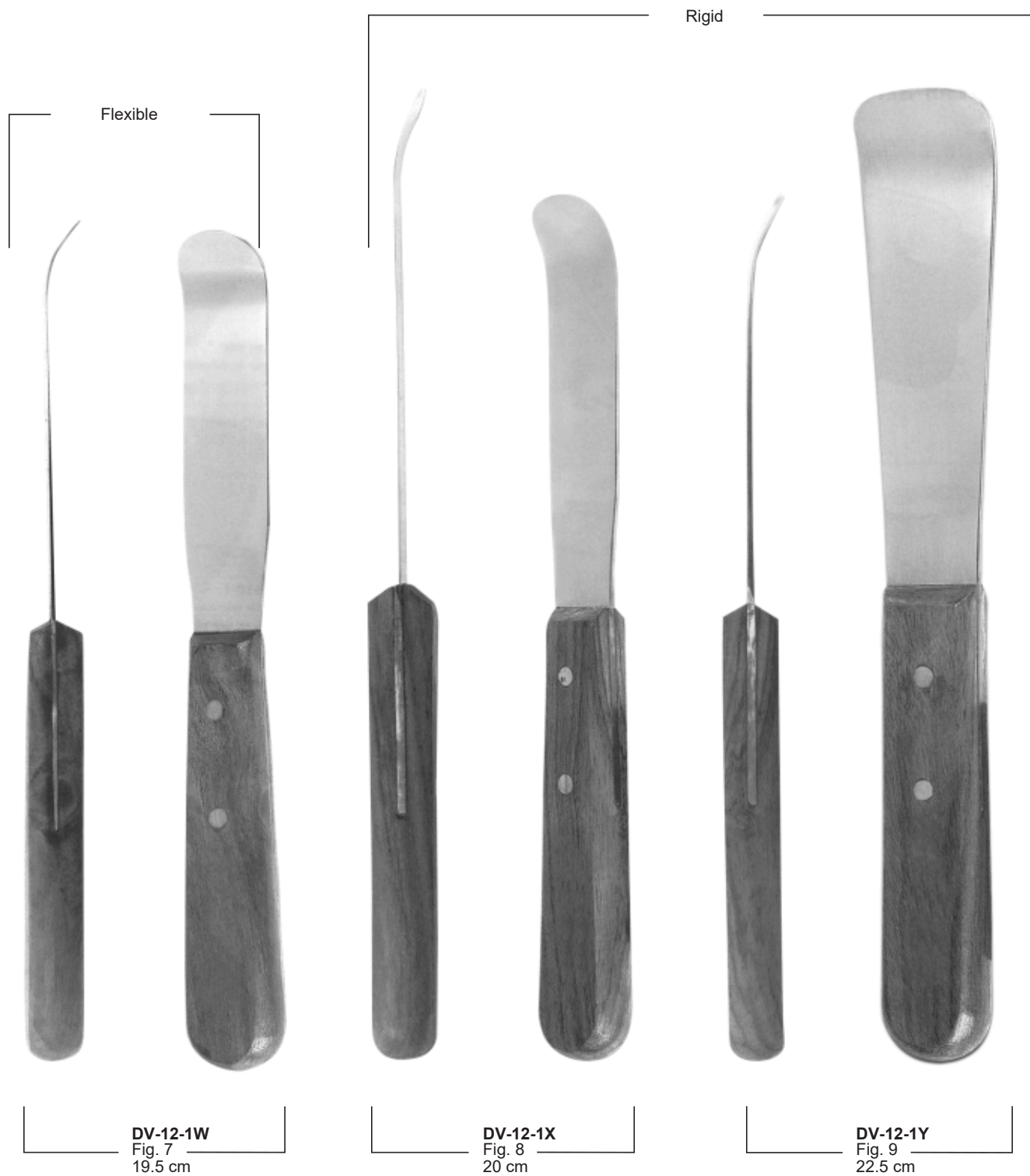



Page 94-100

- Needle Holders

www.dentovos.com



DV-13-1A
Mayo-Hegar
16 cm



DV-13-1B
Mayo-Hegar TC
16 cm



DV-13-1C
Mayo-Hegar
18 cm



DV-13-1D
Mayo-Hegar TC
18 cm



DV-13-1E
Mini-Ryder
18 cm



DV-13-1F
Mini-Ryder
15 cm



DV-13-1G
Derf 12 cm



DV-13-1H Hegar-
Baumgarther 14 cm



DV-13-1I
Crile-Wood
15 cm



DV-13-1J
Crile-Wood TC
15 cm



DV-13-1K
Adson
17.5 cm



DV-13-1L
Olsen-Hegar
14 cm



DV-13-1M
Baumgarther
14.5 cm



DV-13-1N
Gillies 16
cm



DV-13-1O
Gillies 16
cm



DV-13-1P Hegar-
Baumgarther 14 cm



DV-13-1Q
Toennis
18 cm



DV-13-1R
Toennis
18 cm



DV-13-1S
Lichtenberg
17 cm



DV-13-1T
Lichtenberg
17 cm



DV-13-1U
Eiselberg-Mathieu
19.5 cm



DV-13-1V
Boynton
12 cm



DV-13-1W
Arruga 16
cm



DV-13-1X
Boynton
12 cm



DV-13-1Y
Arruga 16
cm



DV-13-1Z
Castroviejo
14 cm



DV-13-2A
Castroviejo
14 cm



DV-13-2B
Castroviejo
14/60 cm



DV-13-2C
Castroviejo
18 cm



DV-13-2D
Castroviejo
18 cm



DV-13-2E
Castroviejo
14 cm

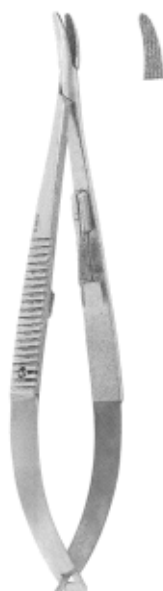

DV-13-2F
Castroviejo
14 cm



DV-13-2G
Castroviejo
14/60 cm



DV-13-2H
Castroviejo
18 cm



DV-13-2I
Castroviejo
18 cm



DV-13-2J
Mathieu
14 cm



DV-13-2K
Mathieu
14 cm



DV-13-2L
Mathieu
14 cm



DV-13-2M
Mathieu
14 cm



DV-13-2N
Mathieu
17 cm



DV-13-2O
Mathieu
17 cm



DV-13-2P
Mathieu
14 cm



DV-13-2Q
Micro-Barraquer
18 cm

Needle Holders & Stainless Steel Saliva Ejectors

www.dentovos.com



The tips have tungsten carbide inserts for better handling.



DV-13-2R
Mathieu
17 cm



DV-13-2S
Mathieu
17 cm



DV-13-2T
Micro-Barraquer
14 cm



DV-13-2U
Castroviejo
13 cm



DV-13-2V
Castroviejo-Barraquer
13 cm



DV-13-2W
Castroviejo
13 cm



DV-13-2X
Castroviejo
13 cm



DV-13-2Y
18.03mm,cm



DV-13-2Y
18.04mm,cm



DV-13-3A
18.05mm,cm



DV-13-2Z
Fig.12F FraizR 15.04mm,cm

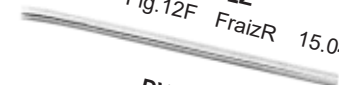

DV-13-3B
Fig.10F FraizR 15.03,3mm,cm

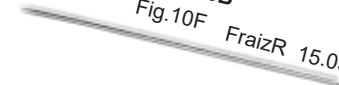
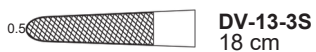
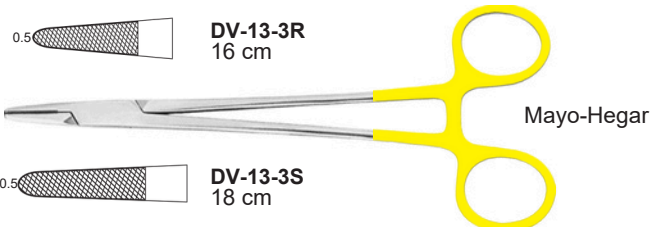
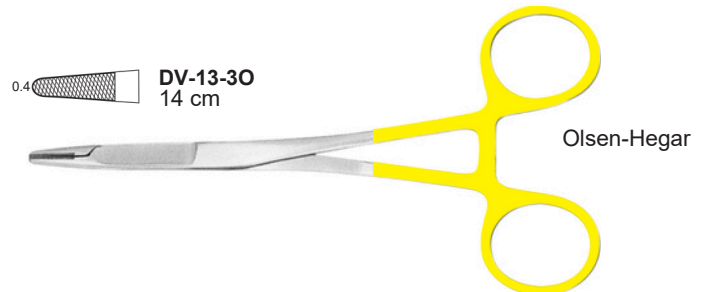
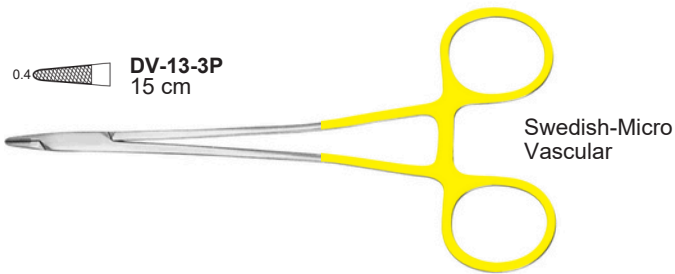
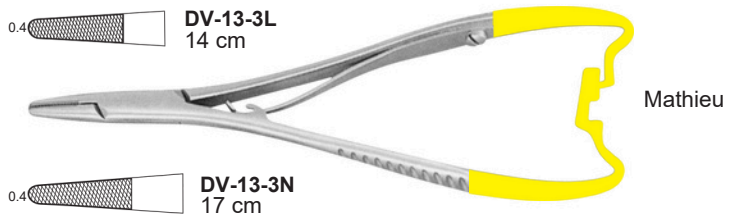
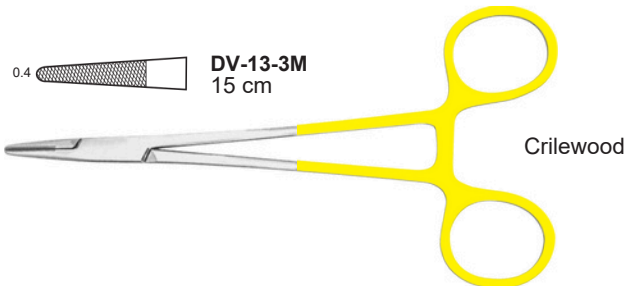
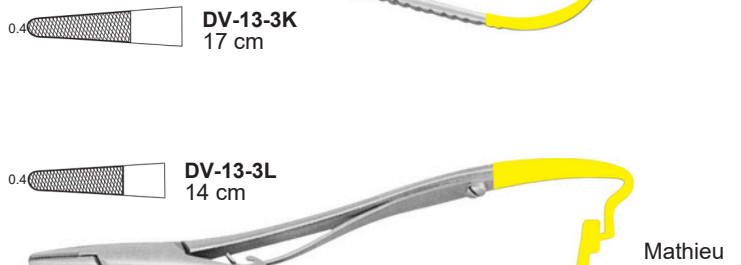
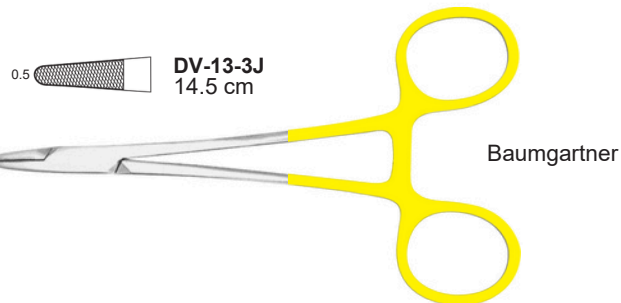
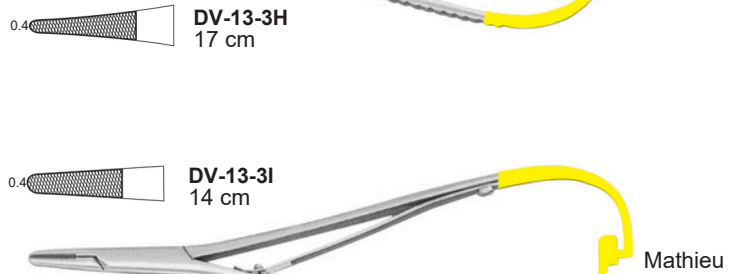
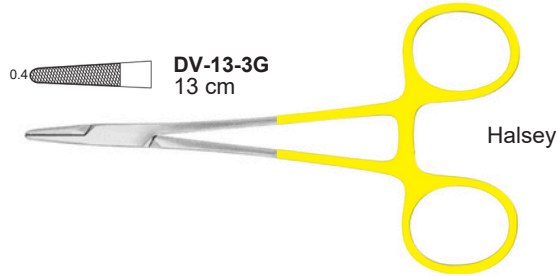
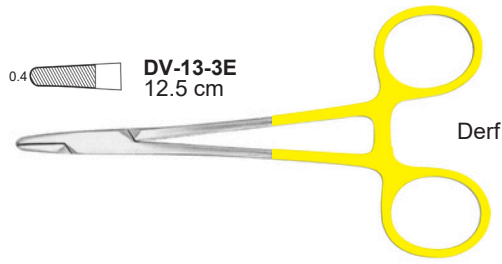

Fig.8FR **DV-13-3C** Fraizer 15.02,7mm,cm



DV-13-3D
Fig.6FR
Fraizer
15.02mm,cm

Needle Holders With Tungsten Carbide Inserts



The logo for Dentovos, featuring the word "DENTOVOS" in a bold, dark blue, sans-serif font. A thin, light blue diagonal line crosses through the letter "O" from the top-left to the bottom-right.

Page 101-109

- Syringes and Scissors

www.dentovos.com

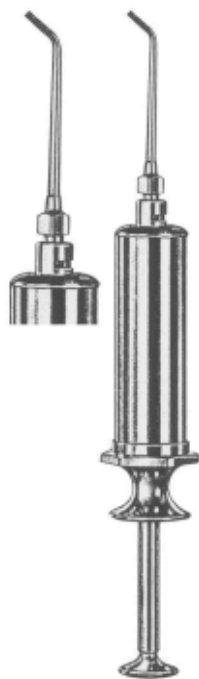

DV-14-1B
Water Syringe complete with
1 cannula (Luer-Lock)



DV-14-1C
Water Syringe complete with
1 cannula (Luer-Lock)



DV-14-1D
Metal water syringe, self-filling,
with 1 cannula (Luer-Lock)



DV-14-1A
Sparrel Barrel with
plunger suitable for
syringes



DV-14-1E
Cannula, only, with
Luer-Lock connector,
suitable for syringes



DV-14-1G
Aspirating Syringe

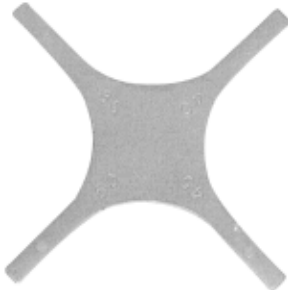

DV-14-1F
Position Gauge

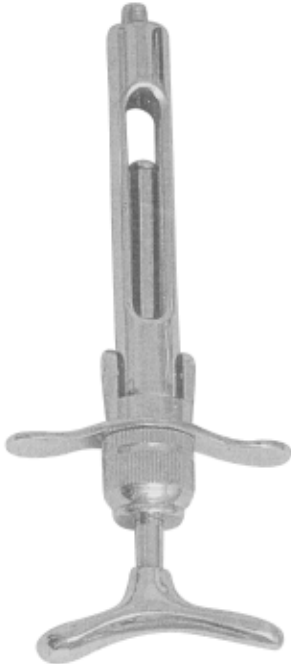

DV-14-1H
Breech Loading Syringe

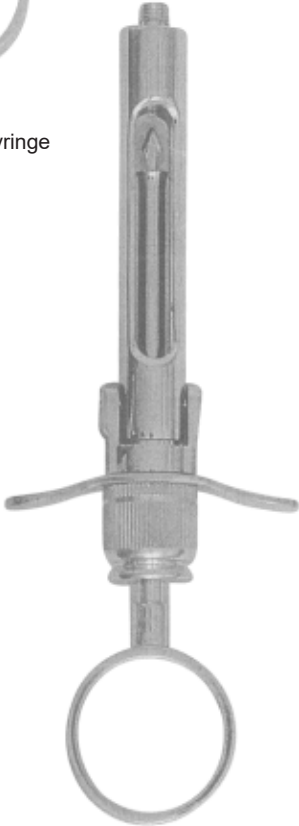

DV-14-1J
Aspirating & Breech Syringe



DV-14-1I
Band Adaptor



DV-14-1K
Endo Finger Ruler
With Adjustable Slide



DV-14-1L
Aspirating Syringe



DV-14-1M



DV-14-1N



DV-14-1R

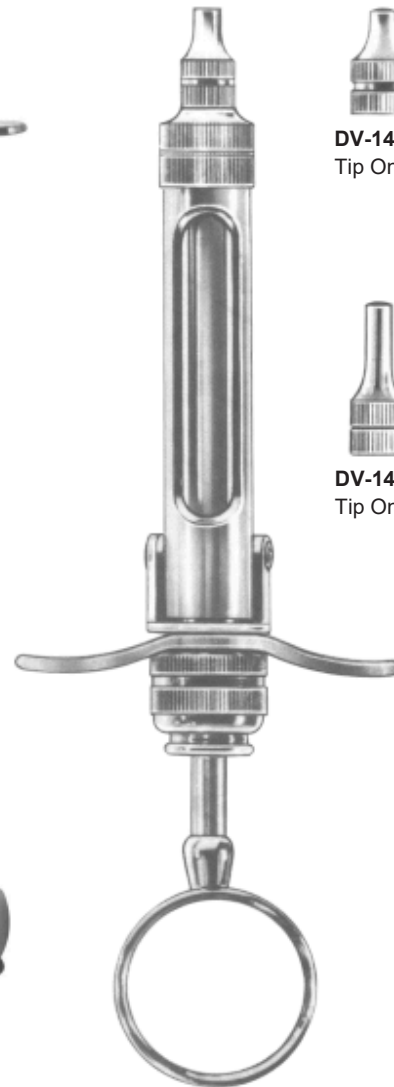

DV-14-1S DV-14-2G

Cartridge Syringe complete
With 2 tips and without needles
1,8 ml
2,2 ml



DV-14-10
Tip Only, short



DV-14-1Q
Tip Only, long



DV-14-1P



DV-14-1T



DV-14-1U



DV-14-1V
Corkscrew tip



DV-14-1W
Cork screw tip



DV-14-1X
Folding type, cork
screw tip



DV-14-1Y
Folding type, cork
screw tip



DV-14-1Z



DV-14-2D
Corkscrew tip



DV-14-2B
Spare cap with
metric thread



DV-14-2C
With Whitworth
thread



DV-14-2A
Autoclavable Plastic Protection sleeve



DV-14-2E
Brass syringe with stainless steel moving parts

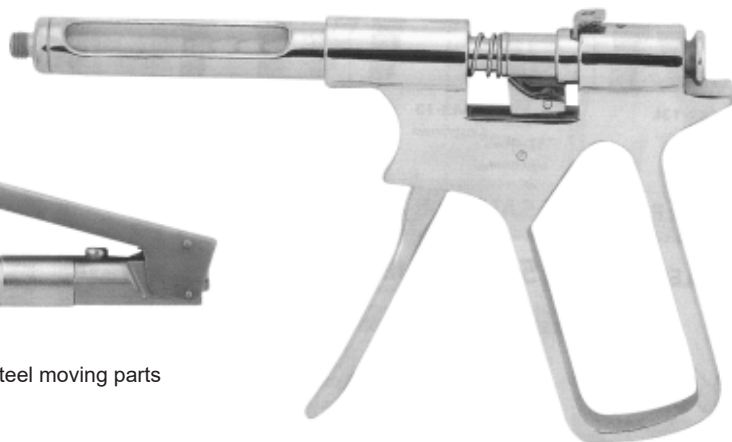

DV-14-2F
Brass syringe with stainless
steel moving parts



Suture Scissors | Tijeras para Hilos | Fadenscheren

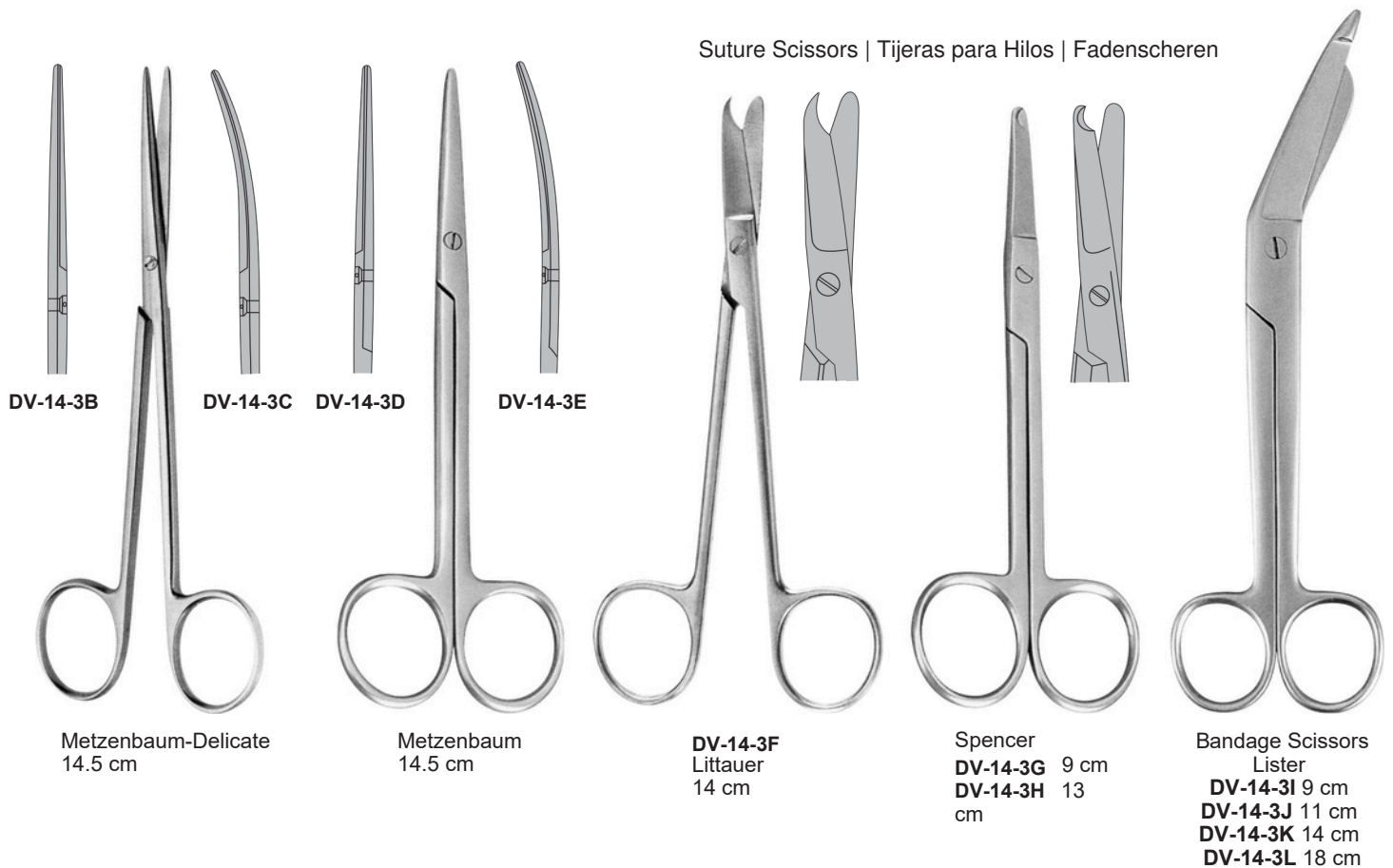

Gum Scissors



Iris
11.5 cm

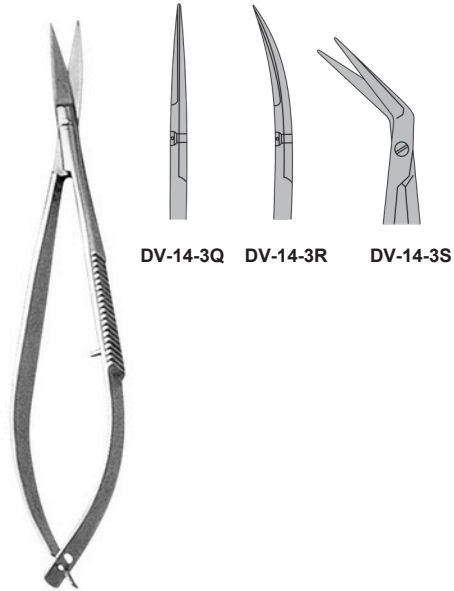

Noyes / Castroviejo
12 cm

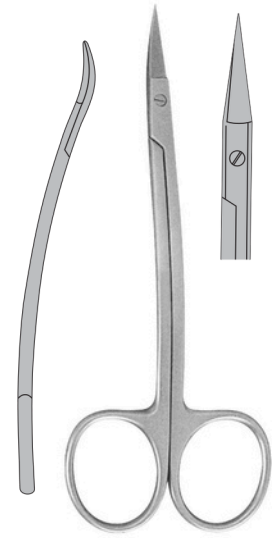

DV-14-3T
La Grange
11.5 cm



DV-14-3U
Universal
18 cm

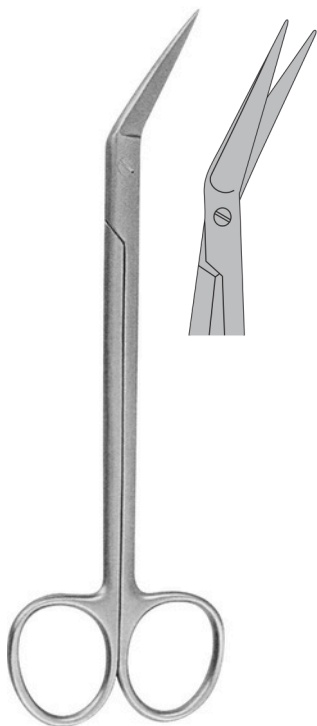

DV-14-3V
Kelly 16
cm

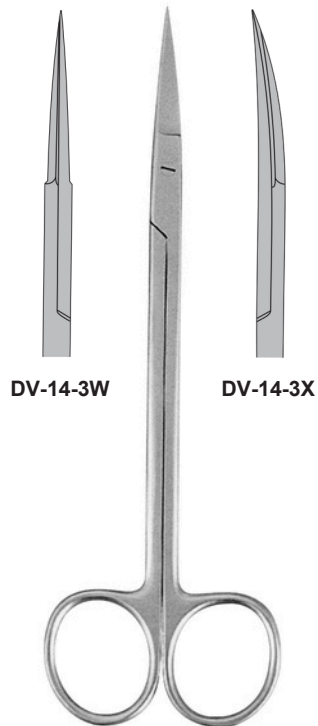

Kelly
16 cm



DV-14-3Y
Goldman-
Fox 13 cm

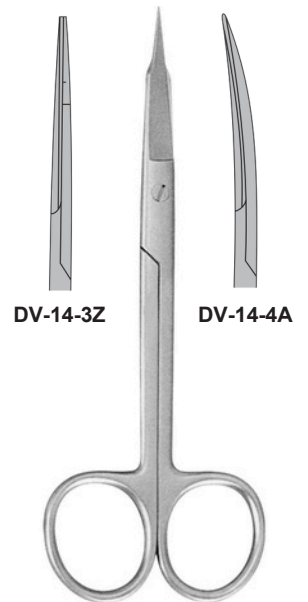

Goldman-Fox
13 cm

Scissors, One Blade Serrated

- One blade is with fine serrations to avoid tissue or ligature slippage.
- Manufactured from high quality stainless steel to provide longer-lasting cutting edge.
- Single black ring for easy identification.



DV-14-4B

DV-14-4C

DV-14-4D

DV-14-4E



Iris
11.5 cm



DV-14-4F

Goldman-Fox
13 cm



DV-14-4G
Goldman-Fox
13 cm

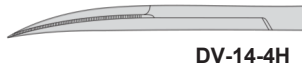

DV-14-4H

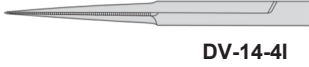

DV-14-4I

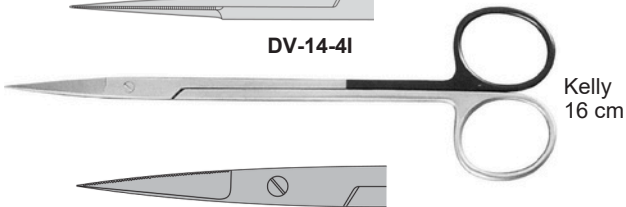

Kelly
16 cm



DV-14-4J
Locklin
16 cm



DV-14-4K
Locklin
16 cm

Super-Cut

- Cutting Blade horned to "razor" sharpness with opposing blade finished with fine serrations to avoid tissue slippage.
- Extremely smooth cutting with less trauma.
- Manufactured from high quality stainless steel to provide longer-lasting cutting edge.
- Single gold plated ring for easy identification.

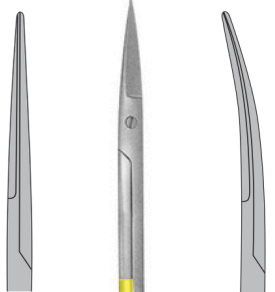

DV-14-4L

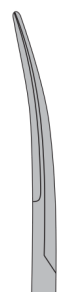

DV-14-4M

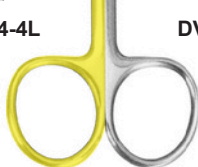

Iris
11.5 cm

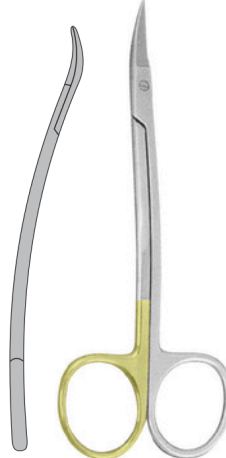

DV-14-4N
La Grange
11.5 cm



DV-14-4O



DV-14-4P

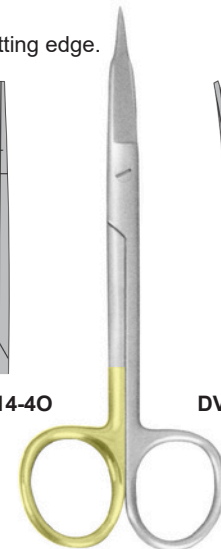

Goldman-Fox
13 cm

Scissors With Tungsten Carbide Inserts

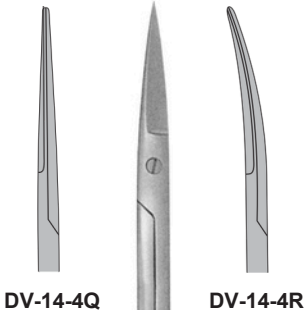

Iris
11.5 cm

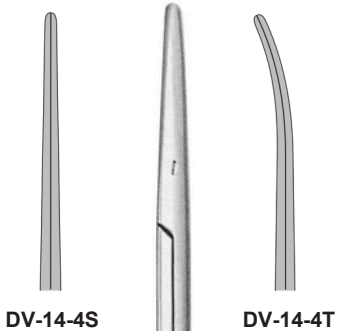

Metzenbaum
14.5 cm

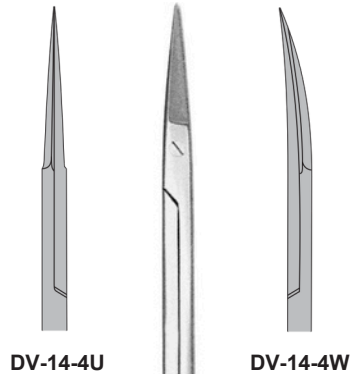

Kelly
16 cm

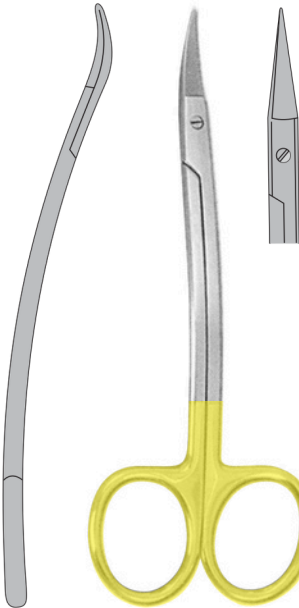

DV-14-4X
La Grange
11.5 cm

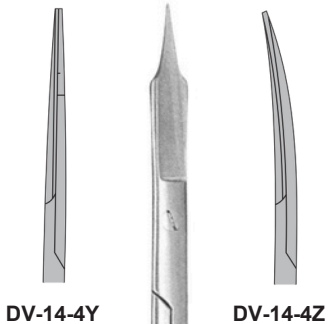

Goldman-Fox
13 cm

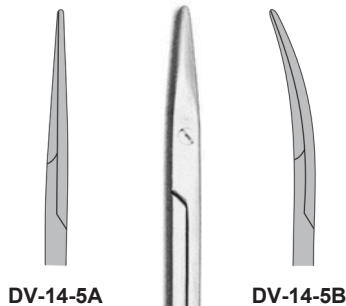

Strabismus
11.5 cm

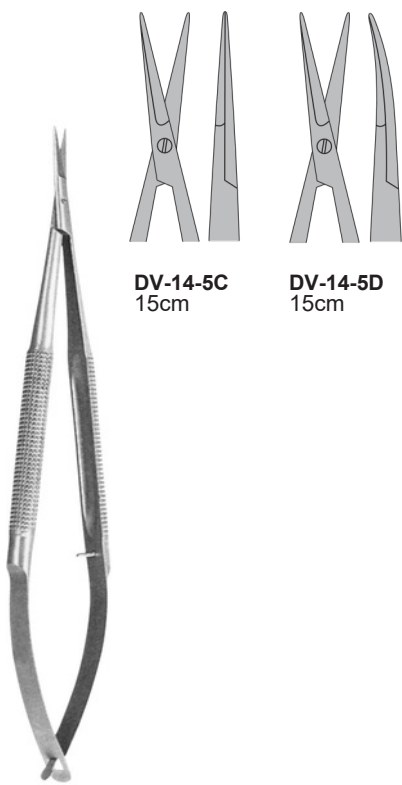

DV-14-5C
15cm

DV-14-5D
15cm

Micro Scissor
Stainless Steel

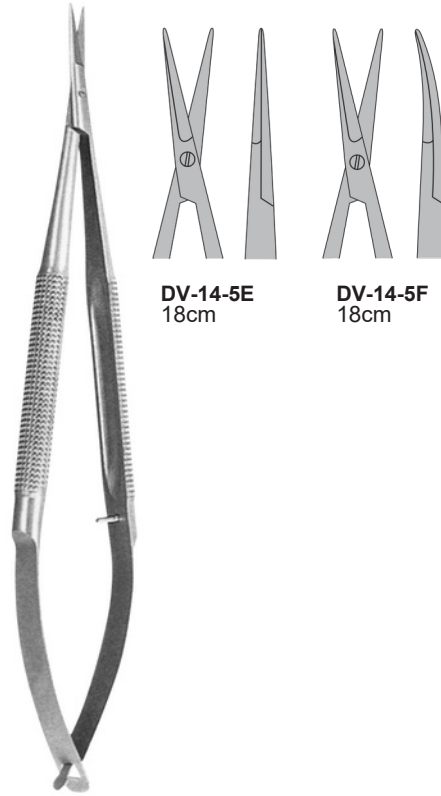

DV-14-5E
18cm

DV-14-5F
18cm

Micro Scissor
Stainless Steel



DV-14-5F
18cm

Micro Scissor
Stainless Steel
for ligature, one blade serrated

Micro Scissors with Titanium Stainless Steel Tips



DV-14-5G
18cm

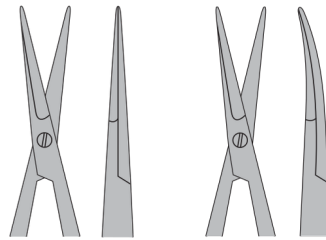

DV-14-5H
18cm

DV-14-5I
18cm



DV-14-5J
15.5 cm

DV-14-5K
15.5 cm

The logo for Dentovos, featuring the word "DENTOVOS" in a bold, dark blue, sans-serif font. A thin, light blue diagonal line crosses through the letter "O" from the top-left to the bottom-right.

DENTOVOS

Page
110-114

- Dental Tweezers

www.dentovos.com



smooth

DV-15-1A
College 15
cm

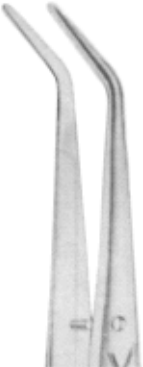

serrated

DV-15-1B
College 15
cm



smooth

DV-15-1C
College 15
cm



serrated

DV-15-1D
College 15
cm



smooth

DV-15-1E
College 15
cm

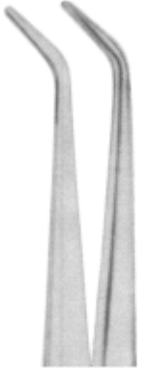

serrated

DV-15-1F
College 15
cm



smooth

DV-15-1G
College 15
cm

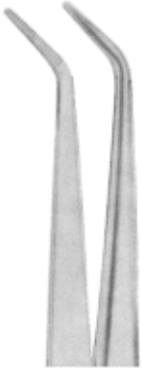

serrated

DV-15-1H
College 15
cm

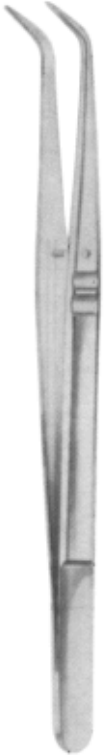

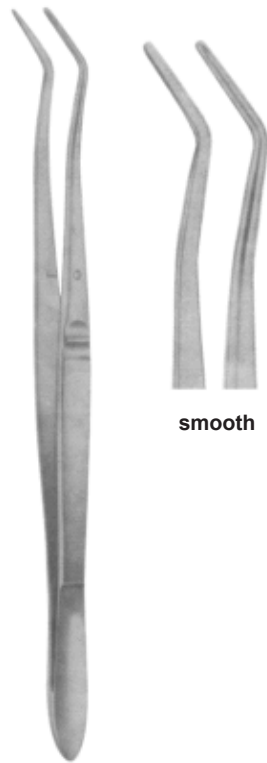

smooth

DV-15-1I
Meriam 16
cm

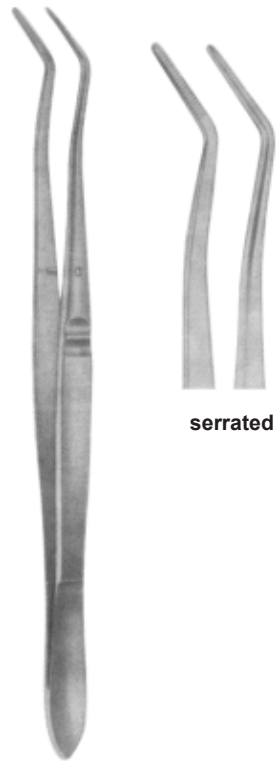

serrated

DV-15-1J
Meriam 16
cm

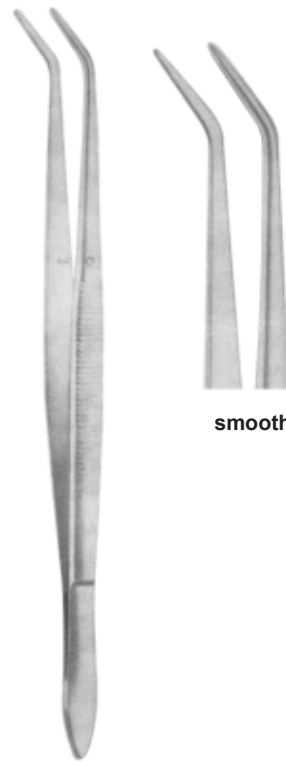

smooth

DV-15-1K
Meriam 16
cm

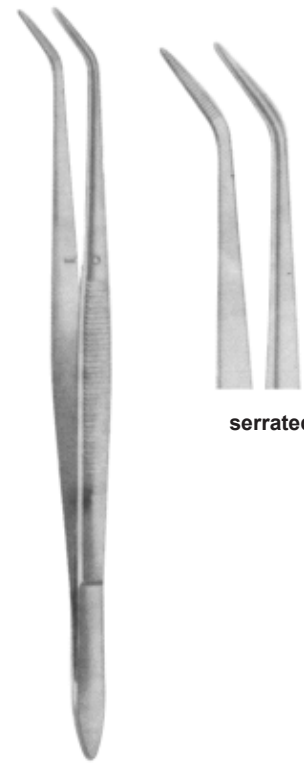

serrated

DV-15-1L
Meriam 16
cm

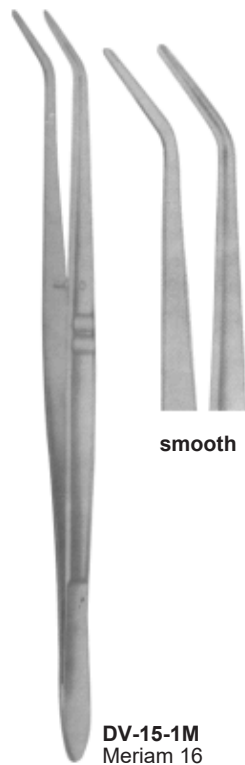

smooth

DV-15-1M
Meriam 16
cm

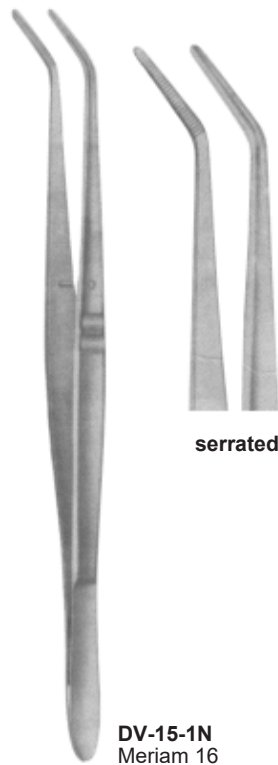

serrated

DV-15-1N
Meriam 16
cm

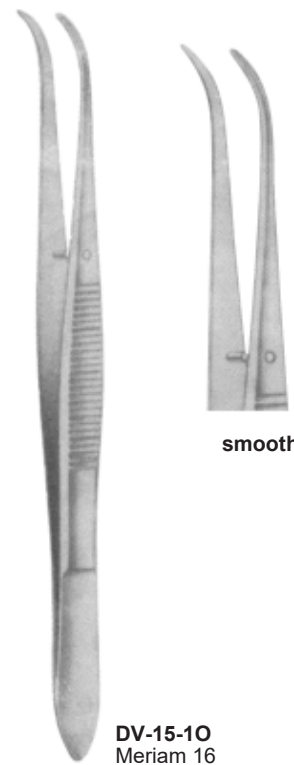

smooth

DV-15-1O
Meriam 16
cm

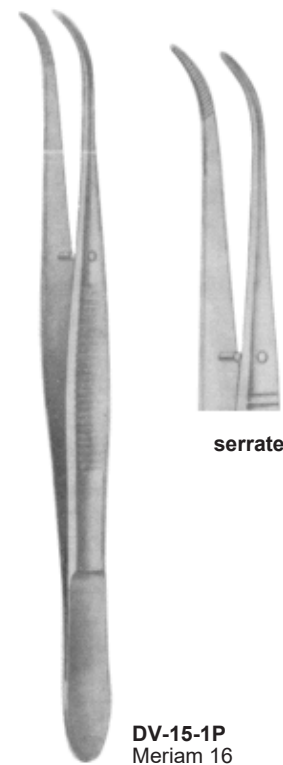

serrated

DV-15-1P
Meriam 16
cm

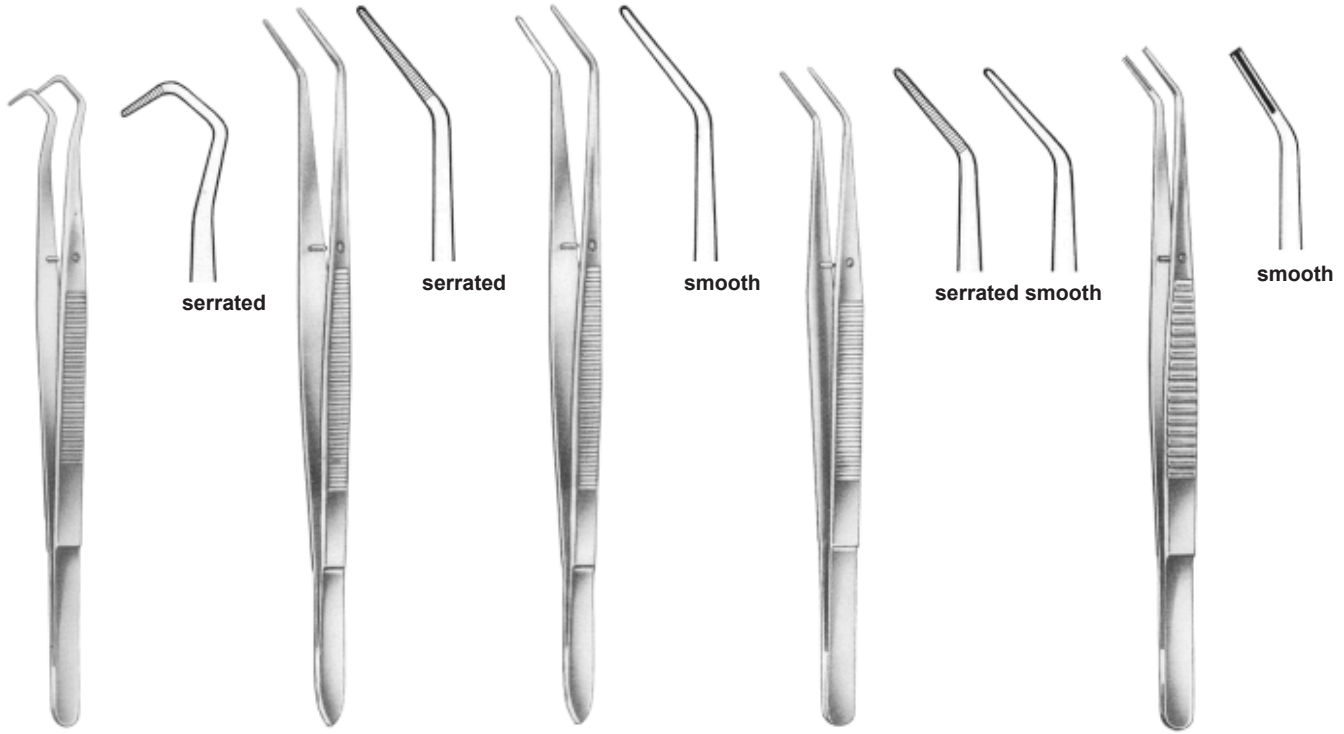

DV-15-1Q
College
14.5 cm, 5³/₄"

serrated

serrated

smooth

serrated smooth

smooth

DV-15-1R
Flagg 16
cm, 6 1/4"

DV-15-1S
Flagg 16
cm, 6 1/4"

DV-15-1T
Landgraf
15 cm, 6"

DV-15-1U
15,5 cm, 6¹/₈"

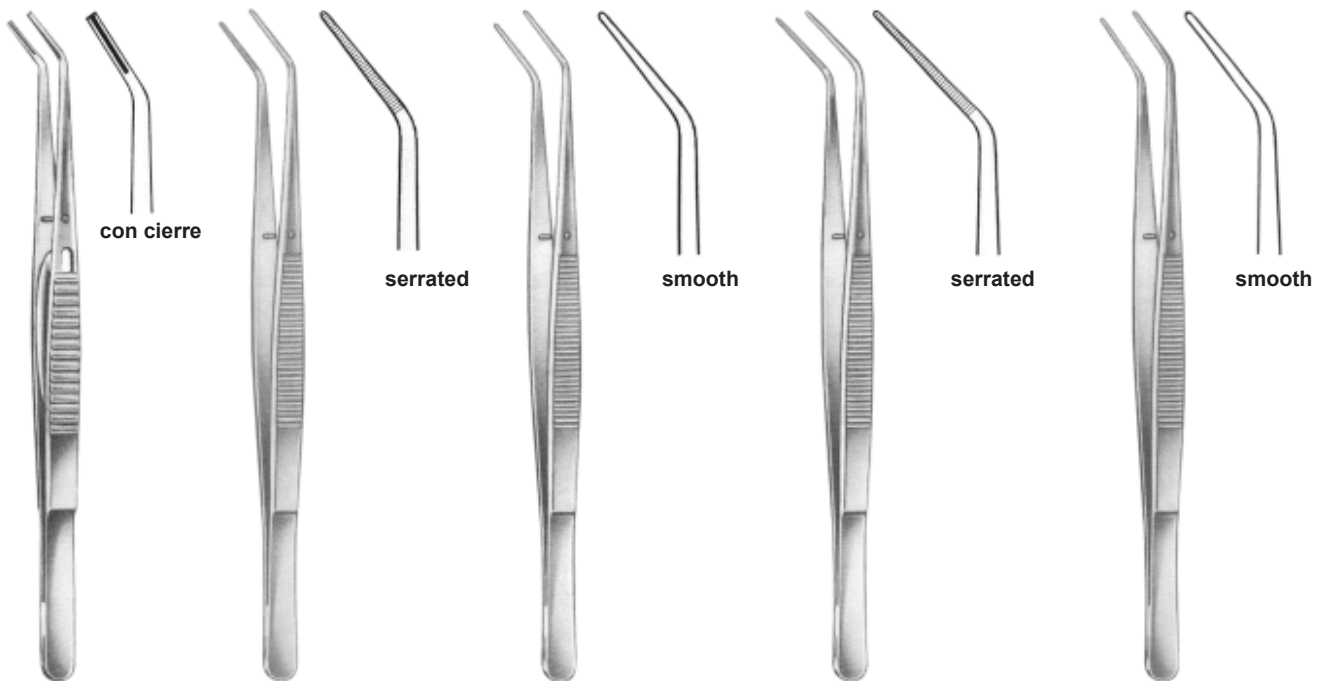

con cierre

serrated

smooth

serrated

smooth

DV-15-1V
15.5 cm, 6¹/₈"

DV-15-1W
London-College
15 cm, 6"

DV-15-1X
London-College
15 cm, 6"

DV-15-1Y
London-College
15 cm, 6"

DV-15-1Z
London-College
15 cm, 6"



DV-15-2A
CK1 15
cm, 6"

DV-15-2B
CK2 15
cm, 6"

DV-15-2C
GF2 16
cm, 6 1/4"

DV-15-2D
Gf1 16 cm,
6 1/4"

DV-15-2E
Kopp 15.5
cm, 6 1/8"

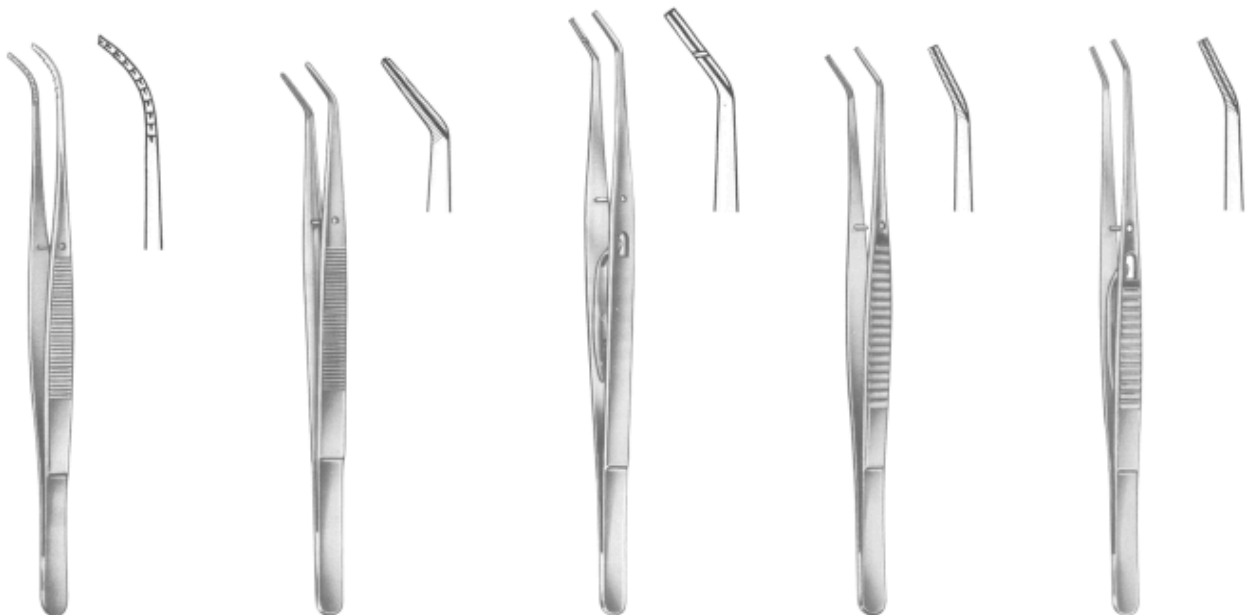

DV-15-2F
Kopp 15.5
cm, 6 1/8"

DV-15-2G
15 cm, 6"

DV-15-2H
16.5 cm, 6 1/2"

DV-15-2I
15.5 cm, 6 1/8"

DV-15-2J
15.5 cm, 6 1/8"

DENTOVOS



DV-15-2K
London-College
15 cm, 6"

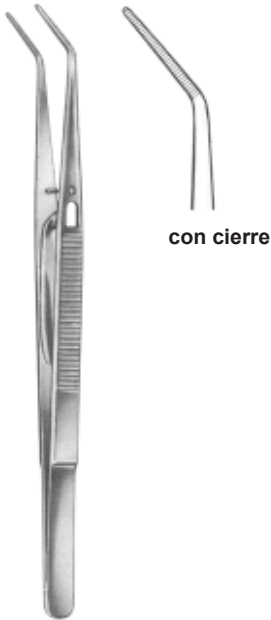

DV-15-2K
London-College
15 cm, 6"

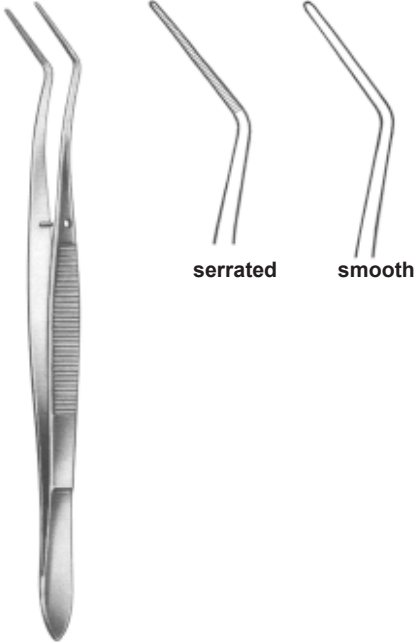

DV-15-2L
Meriam 16
cm, 6 1/4"

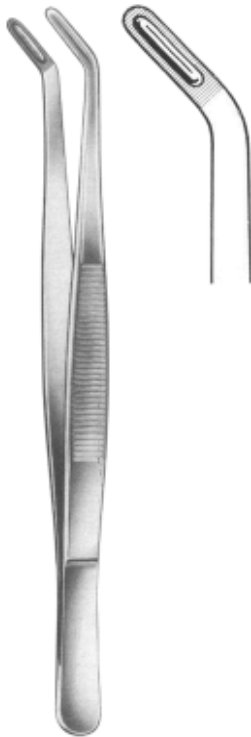

DV-15-2M
Allen 18
cm, 7 1/8"



DV-15-2N
Albrecht
16 cm, 6 1/4"



DV-15-2O
Albrecht
16 cm, 6 1/4"



DV-15-2P
16 cm, 6 1/4"



DV-15-2Q
16 cm, 6 1/4"



DV-15-2R
16 cm, 6 1/4"



Page 115-117

- Rubber Dam Clamps

www.dentovos.com



RUBBER DAM FRAME

DV-16-1A
Young
105x95 Inox

DV-16-1B
Ivory 160
mm

DV-16-1C
Ainsworth
170 mm

DV-16-1D
Ainsworth
170 mm

DV-16-1E
Mershan
140 mm

CLAMPS (PLIERS)

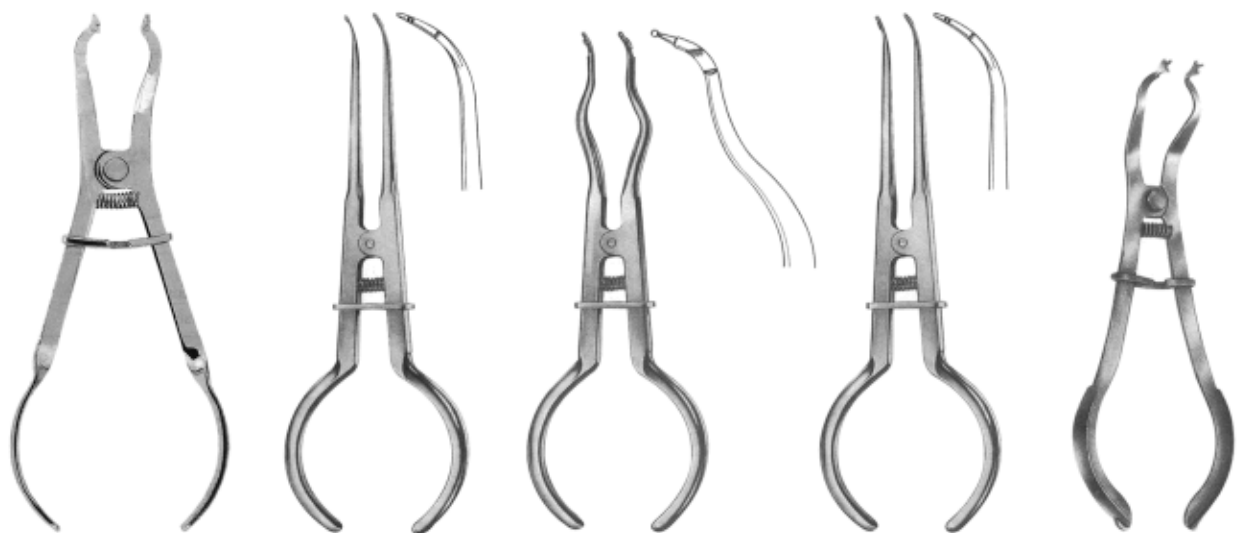

DV-16-1F
Ivory lightweight
170 mm

























DV-16-1G
Brewer
175 mm

DV-16-1H
Brewer
175 mm

DV-16-1I
White 175
mm

DV-16-1J
Ivory 170
mm

Rubber Dam Clamps

<p>Anterior</p>  <p>DV-16-1K Winged Labial Clamp</p>	<p>Premolars</p> 	 <p>DV-16-1L Winged</p>	 <p>DV-16-1M Winged</p>	 <p>DV-16-1N Wingless</p>
<p>For Small Teeth, Elongated or With Narrow Collars</p>				
 <p>DV-16-1O Winged Edged Labial Clamp</p>		 <p>DV-16-1P Winged</p>	 <p>DV-16-1Q Winged</p>	 <p>DV-16-1R Wingless</p>
<p>For General Use With Adjustable Jaws According To Gingival Line Shapes</p>				
 <p>DV-16-1S Winged Cervical Clamp</p>		 <p>DV-16-1T Winged</p>	 <p>DV-16-1U Edged, Winged</p>	 <p>DV-16-1W Wingless</p>
<p>For Premolars, With Elongated Collar</p>				
 <p>DV-16-2A Winged Labial Clamp</p>		 <p>DV-16-1X Winged</p>	 <p>DV-16-1Y Edged, Winged</p>	 <p>DV-16-1Z Wingless</p>
<p>For Premolars, With Elongated Collar</p>				
		 <p>DV-16-2B Wingless</p>		 <p>DV-16-2C Wingless</p>



DV-16-2D
Winged



DV-16-2E
Wingless

For Small Lower Molars



DV-16-2F
Winged



DV-16-2G
Wingless

For Small Lower Molars With Round clamps



DV-16-2H
Winged



DV-16-2I
Wingless

For Square Lower Molars



DV-16-2J
Winged



DV-16-2K
Wingless

For Round Upper Molars



DV-16-2L
Winged



DV-16-2M
Wingless

For Molar Roots



DV-16-2N
Winged



DV-16-2O
Wingless

For Partially Broken Molars



DV-16-2P
Winged



DV-16-2Q
Edged Winged



DV-16-2R
Wingless

For Round Molars, Partially Broken, Undersized or Inclined



DV-16-2S
Winged



DV-16-2T
Wingless



DV-16-2U
Wingless



DV-16-2V
Wingless



DV-16-2W
Winged



DV-16-2X
Winged

The logo for Dentovos, featuring the word "DENTOVOS" in a bold, dark blue, sans-serif font. A thin, light blue diagonal line crosses through the letter "O" from the top right to the bottom left.

Page 118-122

- Matrix Retainer
- Matrix Bands

www.dentovos.com



DV-17-1A
Ivory
63mm

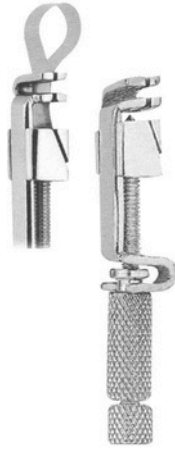

DV-17-1B
Tofflemire-Universal



DV-17-1C
Tofflemire-Junior



DV-17-1D
Tofflemire-Senior



DV-17-1E
Ivory 8
5 mm



DV-17-1F
Ivory 8
6 mm



DV-17-1G
Ivory 8 7
mm



DV-17-1H
Ivory 8 N



DV-17-1I
Didner 8 P



DV-17-1J



DV-17-1K



DV-17-1L



DV-17-1N

1750-5 mm x 100 cm
1750-6 mm x 100 cm
1750-7 mm x 100 cm



DV-17-1M

For Molars and Premolars



DV-17-1O



DV-17-1P



DV-17-1Q

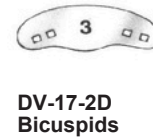
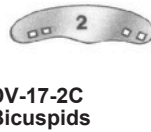
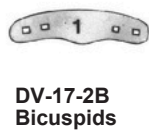
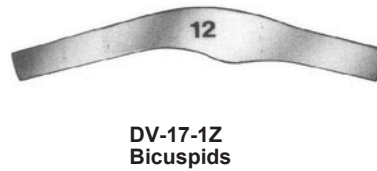
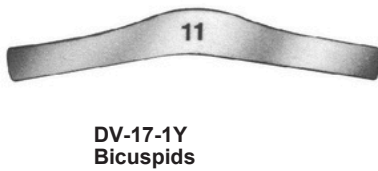
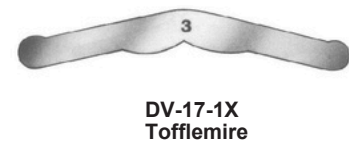
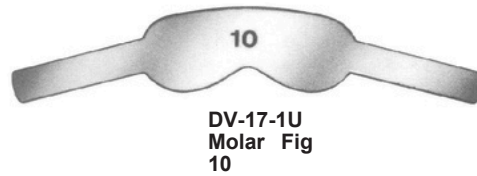
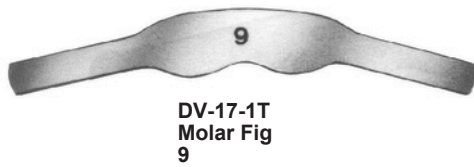
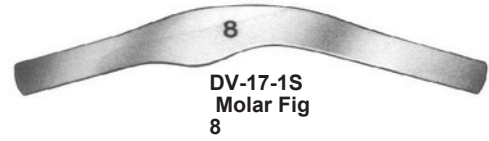

DV-17-2E





Page 120-122

- Crown Removers
- Scissors
- Forceps
- Amalgum Guns
- Carries

www.dentovos.com

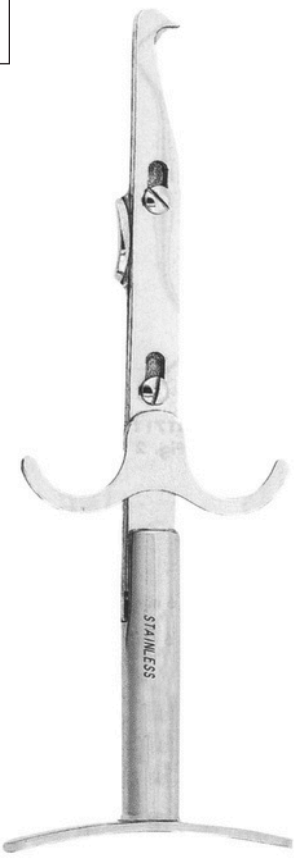
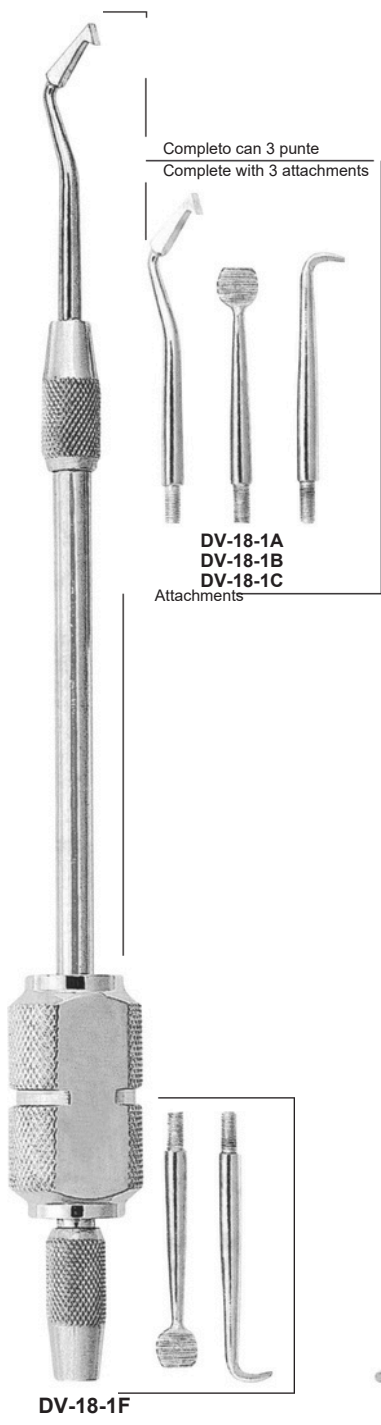

DV-18-1G
Crown Spreader, Crown Remove.
Special instrument for crown spreading
after separating, simple and safe
operation.

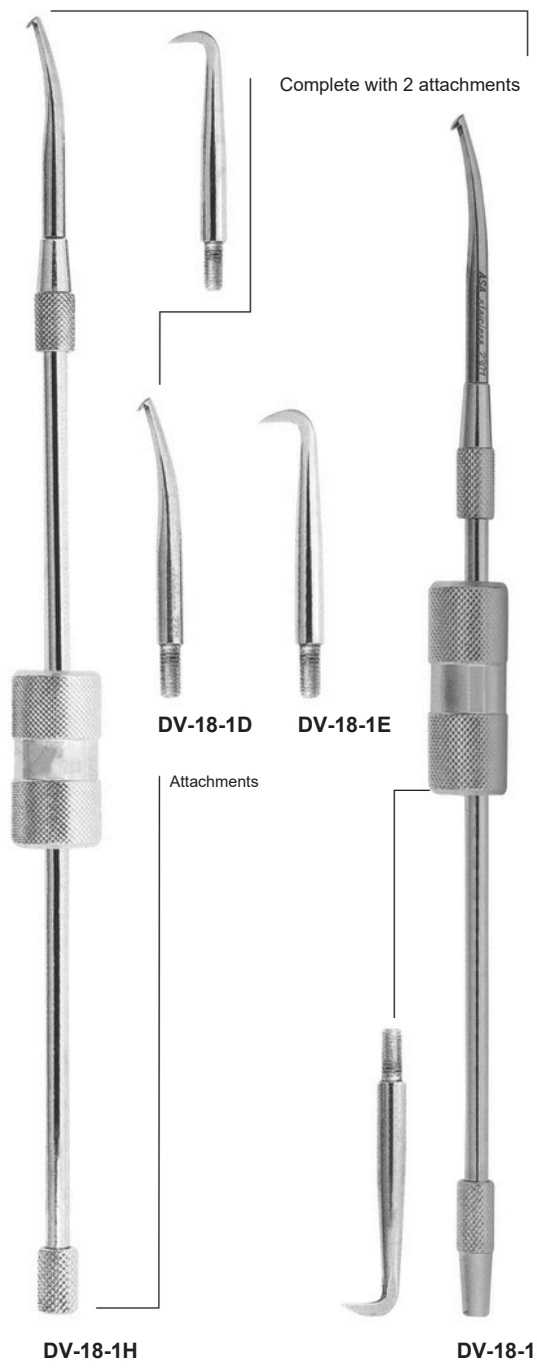



Universal "HM"
12 cm, 4 3/4"

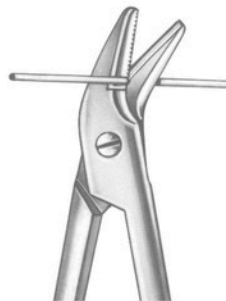

DV-18-1J

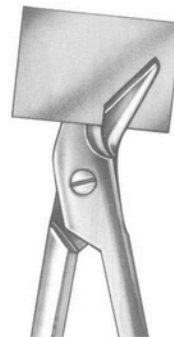

DV-18-1K



DV-18-1L
Beebee
10,5 cm, 4 1/8"



DV-18-1M
Mershon



DV-18-1N
Morell



DV-18-1O
Morell



DV-18-1P
Morell



DV-18-1Q
Morell



DV-18-1R
Treyman



DV-18-1U
Automatic Crown Remover
With 2 Points



DV-18-1S



DV-18-1T

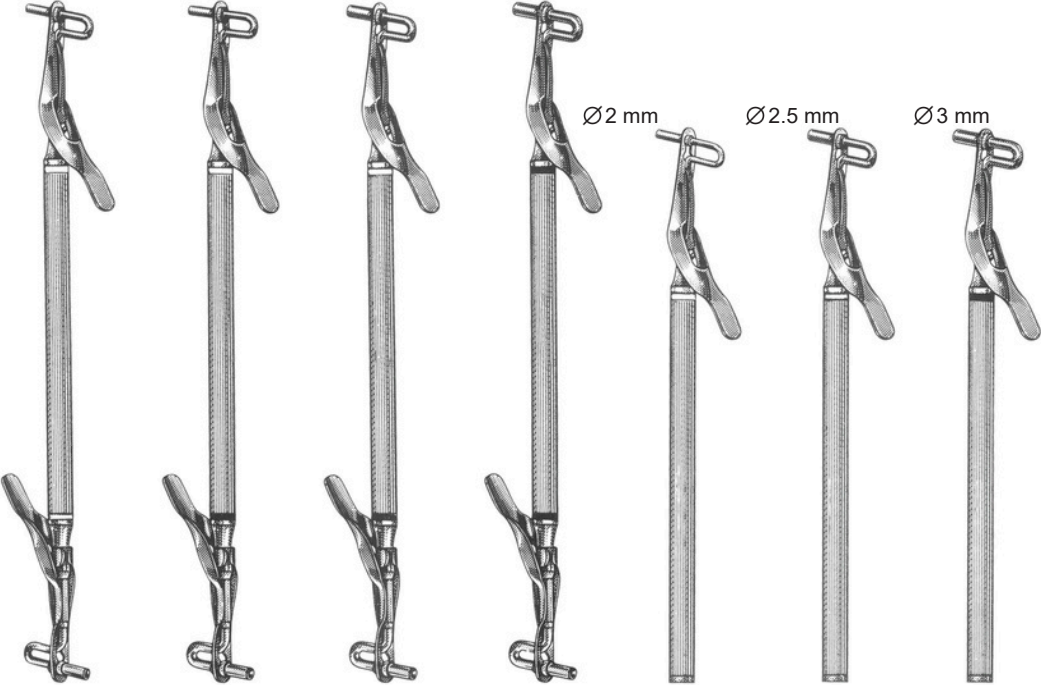

DV-18-1W
Medium-Large
20 cm

DV-18-1X
Medium-Jumbo
20 cm

DV-18-1Y
Large-Jumbo
20 cm

DV-18-1Z
Jumbo-Jumbo
20 cm

DV-18-2A
Medium
15.5 cm

DV-18-2B
Large
15.5 cm

DV-18-2C
Jumbo
15.5 cm

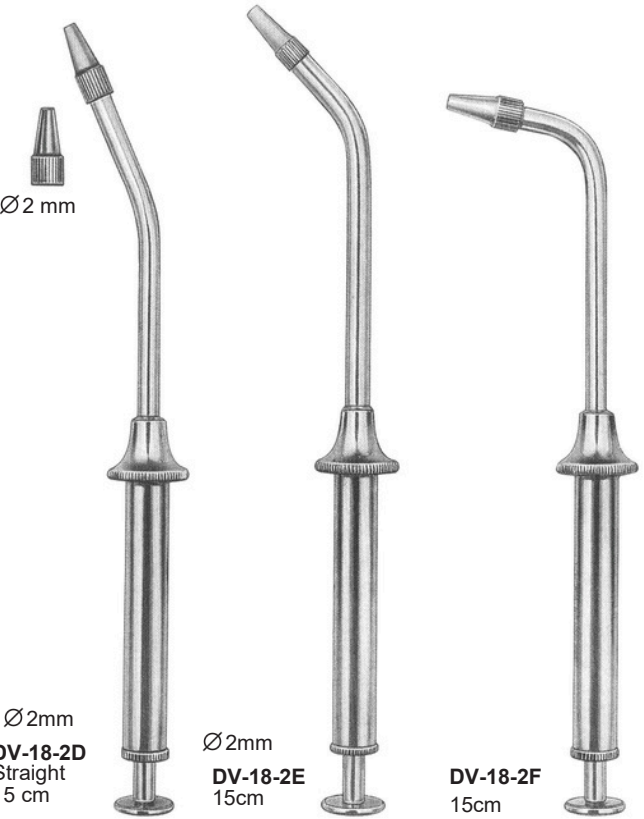

DV-18-2D
Straight
15 cm

DV-18-2E
15cm

DV-18-2F
15cm

90°



DV-18-2G
Amalgam Well
Non Skid Base
Ø3.5 mm



DENTOVOS

Page
123

- CopperRingRemoving Plierspaper Articulator Forceps

www.dentovos.com

Copper ring removing pliers



DV-19-1A
Bohm 11,5
cm



DV-19-1B
Bohm 14,5
cm



DV-19-1C
Furrer 16
cm



DV-19-1D
Furrer 16
cm



DV-19-1E
Miller 15
cm



DV-19-1F
Miller 15
cm



DV-19-1G
Kelly 14
cm



DV-19-1H
Halstead-Mosquito
12 cm



DV-19-1I
Micro-Mosquito
10 cm

The logo for Dentovos, featuring the word "DENTOVOS" in a bold, dark blue, sans-serif font. A thin, light blue diagonal line crosses through the letter "O" from the top right to the bottom left.

Page
124-127

- Rongeurs

www.dentovos.com

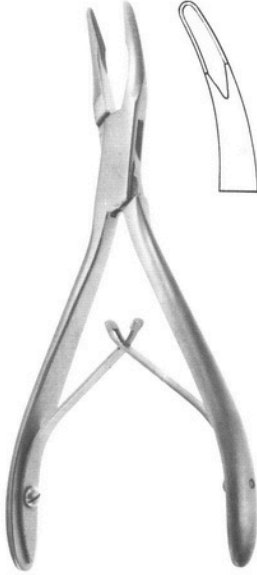

DV-20-1A
Friedmann
14 cm, 5 1/2"



DV-20-1B
14 cm, 5 1/2"

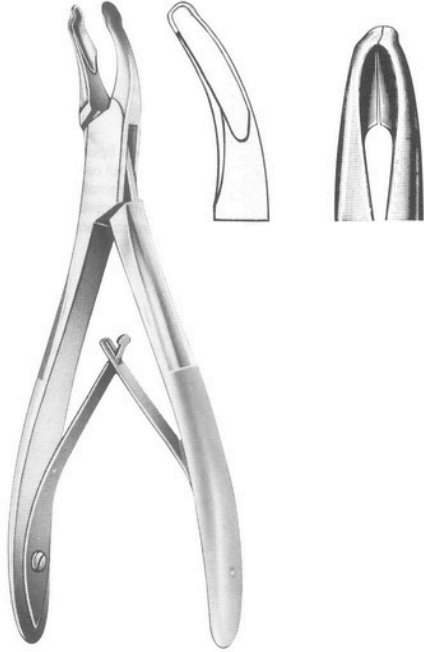

DV-20-1C
Mead 14
cm, 5 1/2"



DV-20-1D
Mead 14
cm, 5 1/2"



DV-20-1E
Mead 17
cm, 6 3/4"

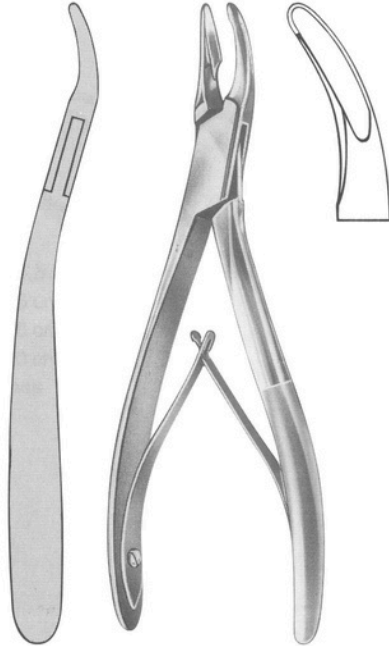

DV-20-1F
Schell 17
cm, 6 3/4"



DV-20-1G
Luer 15
cm



DV-20-1H
Friedman
14 cm



DV-20-1I
Mini Friedman
12 cm



DV-20-1J
Goldman-Fax
10 cm



DV-20-1K
Blumenthal
15 cm



DV-20-1L
Blumenthal 45
14,5 cm



DV-20-1M
Blumenthal 90
14 cm



DV-20-1N
Bohler
15 cm



DV-20-1O
Kerrison
15 cm

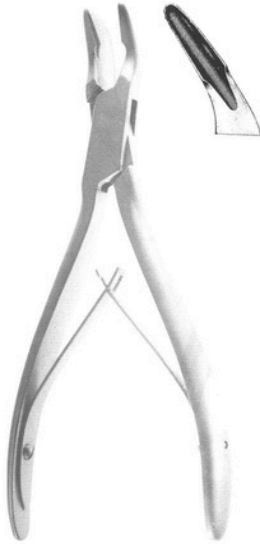

DV-20-1P
Blumenthal
16 cm, 6 1/4"

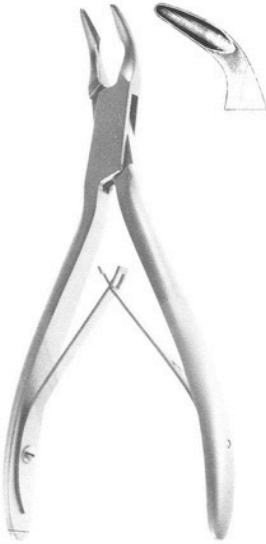

DV-20-1Q
Blumenthal
16 cm, 6 1/4"



DV-20-1R
Blumenthal
16 cm, 6 1/4"

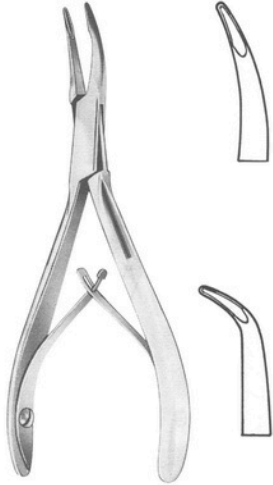

DV-20-1S
Kleinert-Kutz
14 cm, 5 1/2"

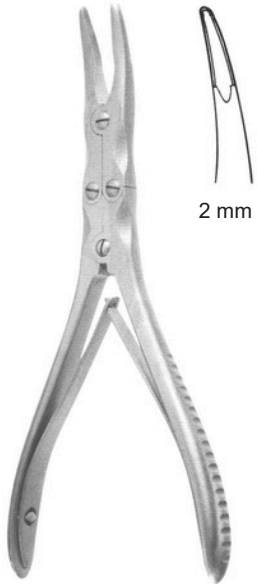

DV-20-1T
Ruskin-Mini
15 cm



DV-20-1U
Beyer 18
cm, 7 1/8"



DV-20-1V
Zaufal-Jansen
18 cm, 7 1/8"

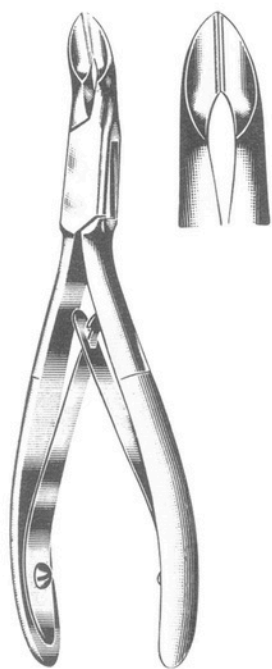

DV-20-1W
Niro No. 5 S, 14
cm, 5 1/2"



DV-20-1X
Cleveland No. 5
S, 17 cm, 6 3/4"



DV-20-1Y
No. 18, 15cm, 6"

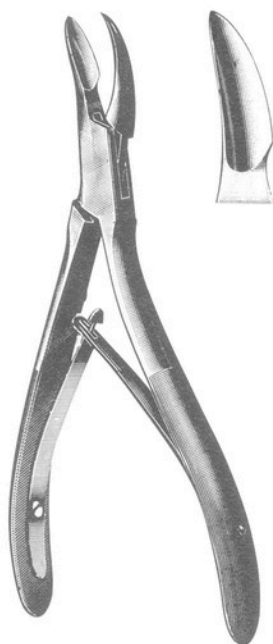

DV-20-1Z
Cleveland
16 cm, 6 1/4"



DV-20-2A
Gardner
16 cm, 6 1/4"



DV-20-2B
Liston-mini
15 cm, 6"

The logo for Dentovos, featuring the word "DENTOVOS" in a bold, dark blue, sans-serif font. A thin, light blue diagonal line crosses through the letter "O" from the top-left to the bottom-right.

Page 128-129

- Bone Elevators, Bone Files and Chisels

www.dentovos.com

Bone Elevators

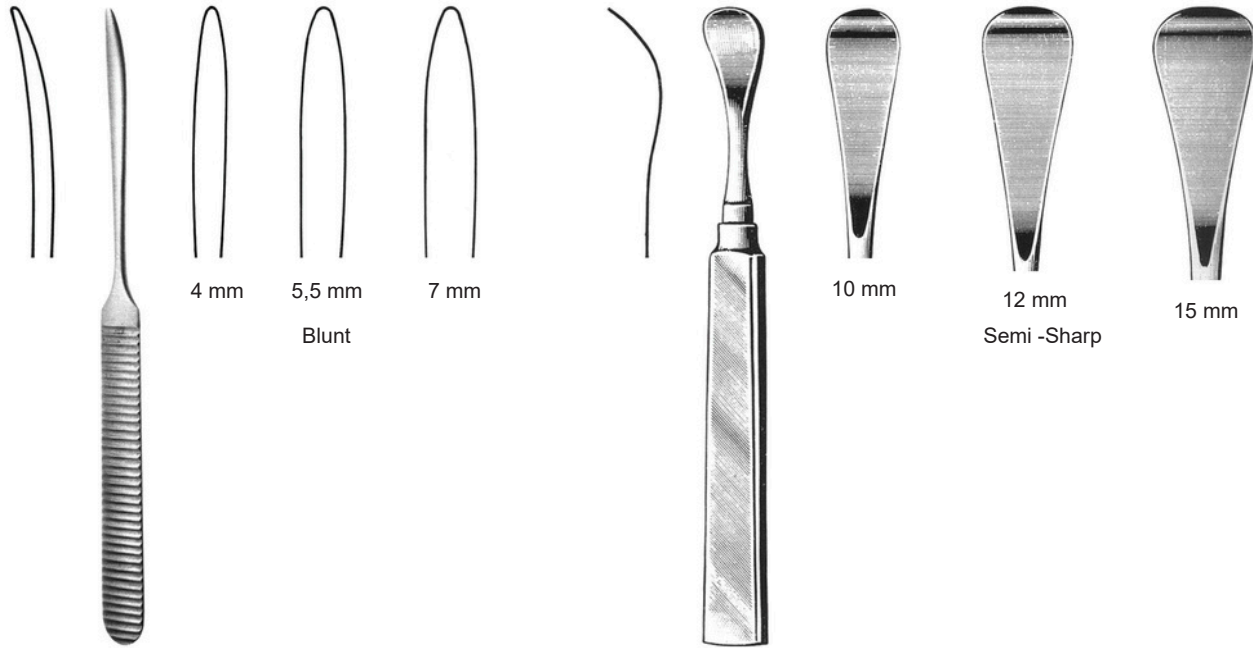

DV-21-1A
Williger 16
cm, 6 1/4"

DV-21-1B
Henahan
17 cm, 6 3/4"

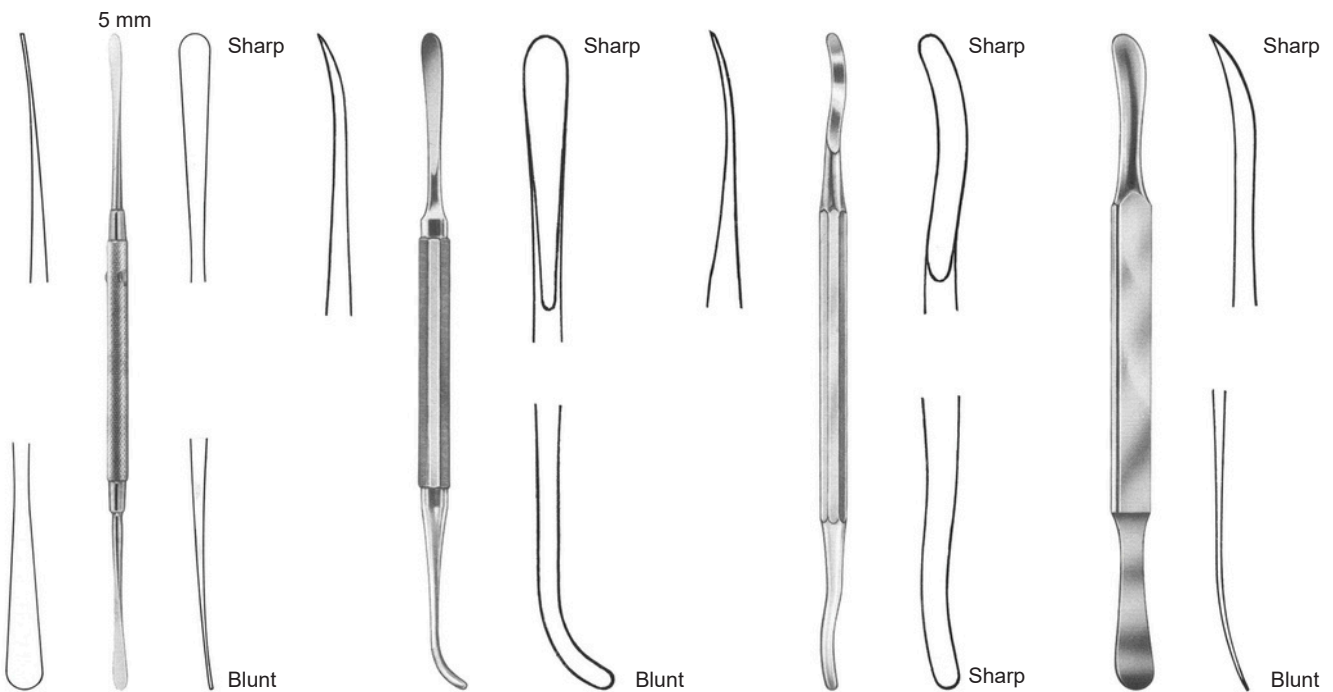

DV-21-1C
Freer 19
cm, 7 1/2"

DV-21-1D
Bennet 17
cm, 6 3/4"

DV-21-1E
Seldin 19
cm, 7 1/2"

DV-21-1F
Seldin
19,5 cm, 7 3/4"

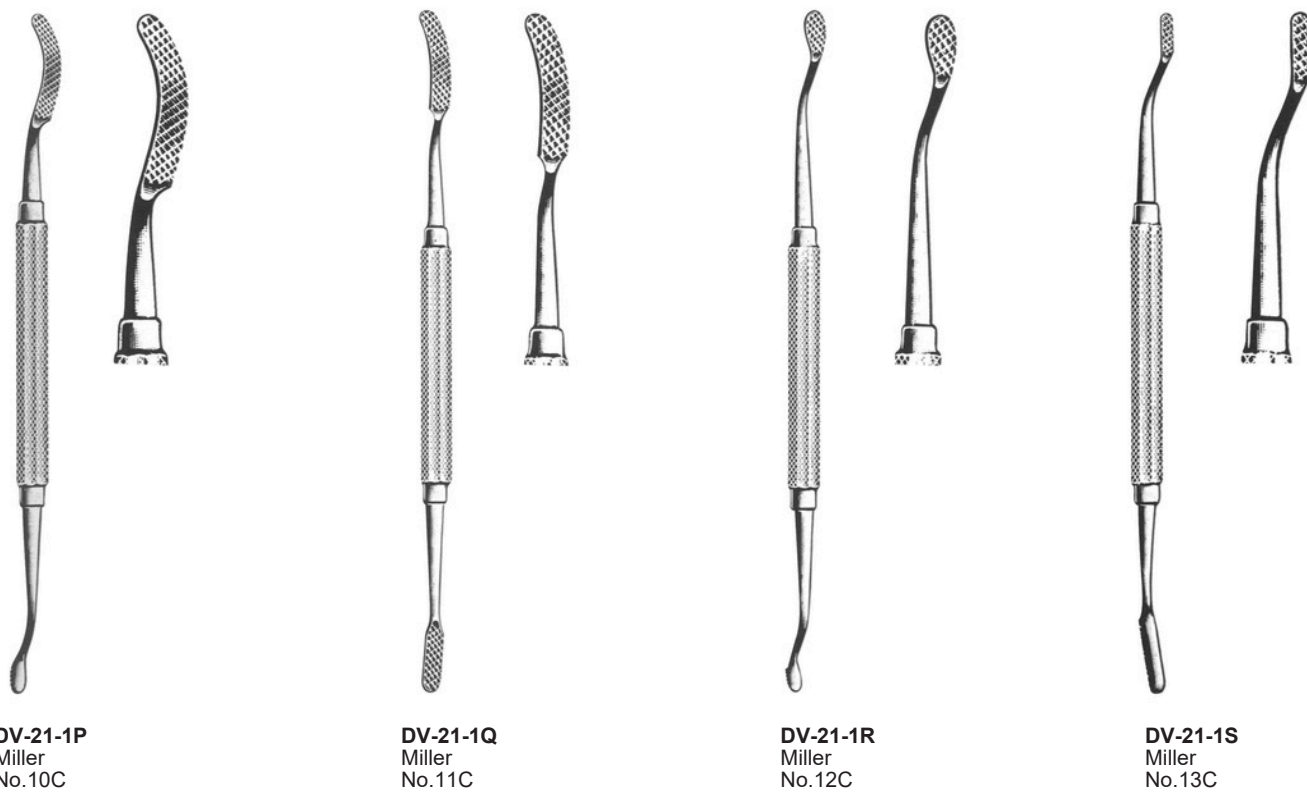
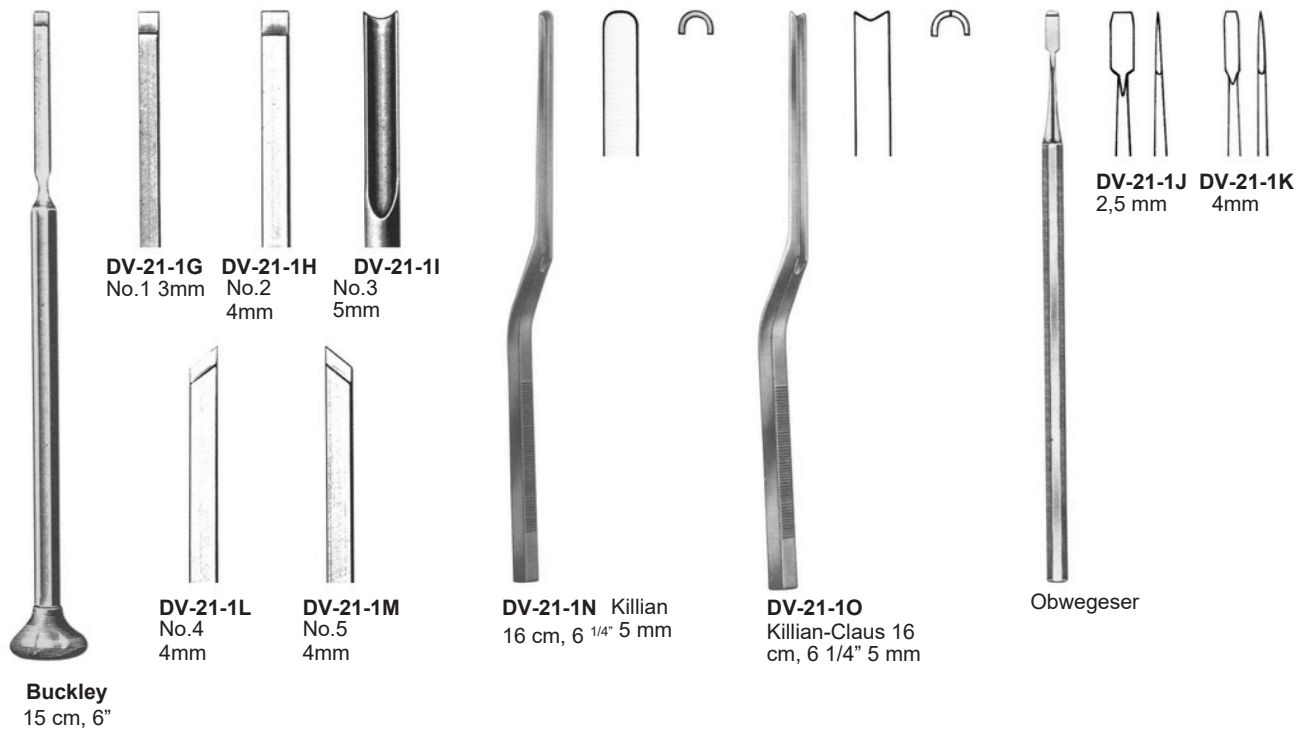

The logo for Dentovos, featuring the word "DENTOVOS" in a bold, dark blue, sans-serif font. A thin, light blue diagonal line crosses through the letter "O" from the top-left to the bottom-right.

Page
130-151

- Pliers ForOrthodontics
- Mouth Gags
- Tongue Depressors
- Lip and Cheek Retractors
- Implantology Instrumetns

www.dentovos.com

Pinze per formare loops
Loops forming pliers



DV-22-1C
Adams
Adams pliers for bending
wires up to 0,7mm. (.28").

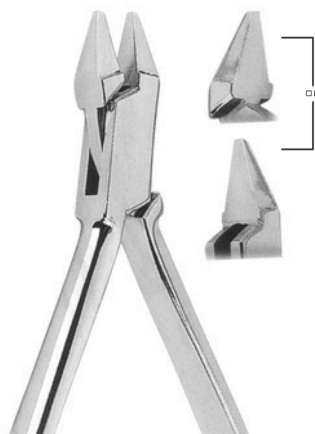

DV-22-1A
Adams
Adams pliers for bending
wires up to 0,7mm. (.28").

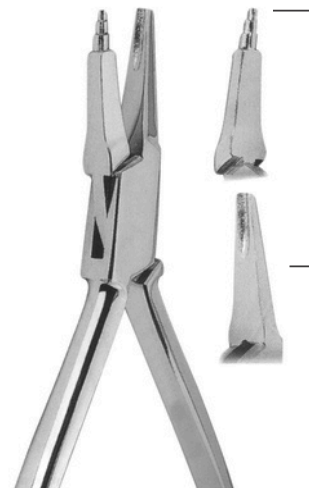

DV-22-1B
Adams
Tweed loop forming pliers.
For forming loop in wires up
to 0,56 mm. (.22").



DV-22-1D
Adams Aderer three jaws
bending
pliers. For wires up
to 0,7 mm. (.28").



DV-22-1E
Adams
Aderer three jaws bending
pliers. For wires upto 0,7 mm.
(.28").

Ligature Cutter Pliers



DV-22-1H

Micro-miniature light wire cutter. It cuts soft ligature wires. For use in caso of limited access. Caution: maximum cutting capacity: soft ligature wire up to 0,30 mm. (.012").



DV-22-1F

Wire cutter. For ligature wires and pins. It is strong enough to bend archwire ends after distal cutting. Maximum cutting capacity up to 0,56 x 0,7 mm. (.022" x .028").



DV-22-1G

Wire cutter. For ligature wires and pins. It is strong enough to bend archwire ends after distal cutting. Maximum cutting capacity: up to 0,9 mm. (.036").



DV-22-1I

Wire cutter. For ligature wires and pins. It is strong enough to bend archwire ends after distal cutting. Maximum cutting capacity: up to 1,5 mm. (.044").

Pinze per formare laboratorio
Laboratory pliers



DV-22-1L

Flat nose pliers with smooth beaks for bending wires up to 0,7 mm. (.028").



DV-22-1J

Bending wires up to 0,7 mm. (.028").



DV-22-1K

Bending wires up to 0,7 mm. (.028").



DV-22-1M

Bending wires up to 0,7 mm. (.028").

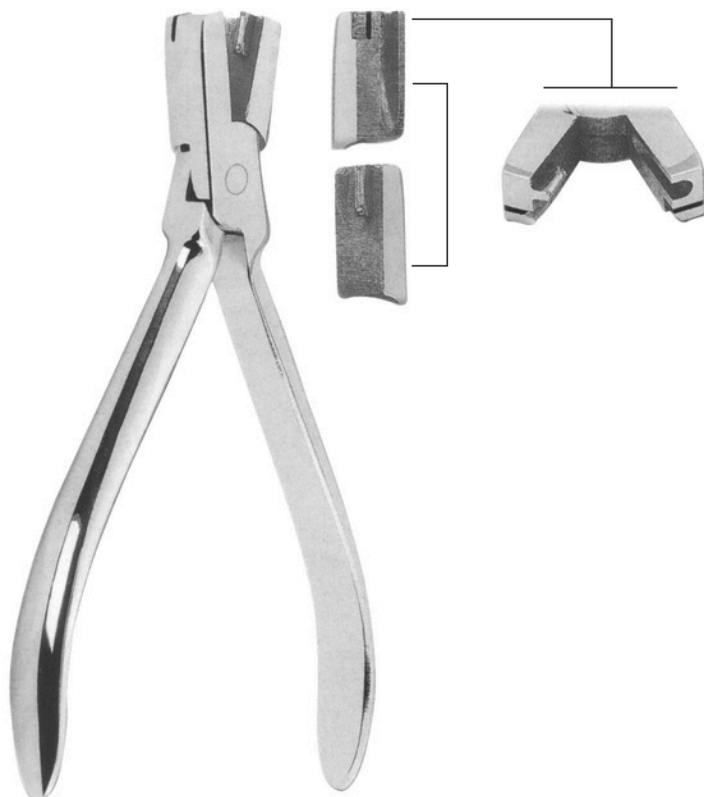

DV-22-1N

Nance

Nance loop closing pliers, for bending of stop loops and special for Adams' clasps. Wires up to 0,7 mm. (.028").



DV-22-10

Nance

Universal pliers for bending wires up to 0,9 mm. (.035") or cutting up to 0,7 mm. (.028").

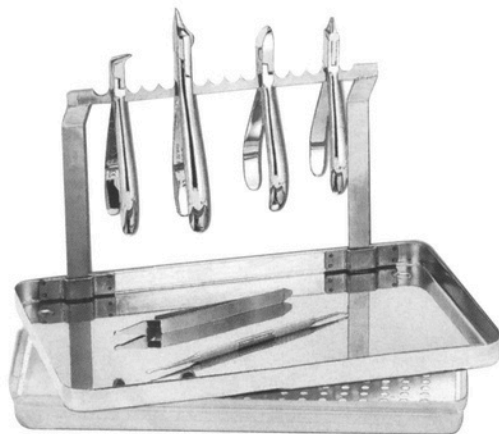

DV-22-1P

Stainless steel pliers tray standard dimensions



DV-22-1Q

Universal

Universal pin roughening, cutting and bending pliers. For wires up to 0,9 mm. (.035"). Will cut wires up to 0,7 mm. (.028").

Utility and specialty pliers



DV-22-1T
Reynolds
Reynolds contouring pliers.



DV-22-1R
Reynolds

Lingual arch pliers used to form double and triple back bends in 0,7 mm (.028") or 0,9 mm (.035") wire for insertion in lingual sheaths.



DV-22-1S
Weingart
Weingart pliers with serrated points.



DV-22-1U
De La Rosa

De La Rosa arch forming pliers. Designed to form and contour arch wires on round or rectangular wire. The beak has grooves of 0,4 mm (.016"), 0,46 mm (.018") and 0,56 mm (.022").



DV-22-1V
DeLaRosa

Arch forming pliers with a non grooved contouring surface the forming of precise arches.

Loop formare pliers



DV-22-1Y
Waldsachs

Waldsachs universal pliers for bending wires up to 1,0 mm. (.039") or cutting up to 0,7 mm. (.028").



DV-22-1W

Round and Concave pliers for loop forming and bending of thin round and square wires up to 0,5 mm. (.020").



DV-22-1X
Tweed

Tweed loop Forming Pliers. For round or rectangular wires up to 0,56 x 0,7 mm. (.022" x .028"). Replaceable cylindrical beak with three sizes: 1,15 mm. (.045), 1,50 mm. (.059"), 1,90 mm. (.075"). Concave beak with slight parallel serrations, to keep the wire in proper position.

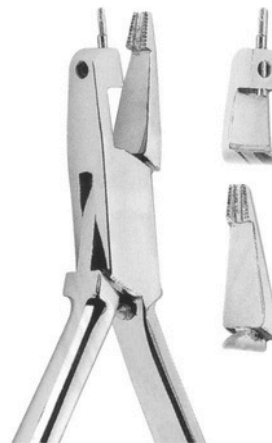

DV-22-1Z
Tweed

Tweed Loop Forming Pliers. For making perfect Omega Loops with round or rectangular wires up to 0,56 x 0,7 mm. (.022" x .028"). The concave beak is exactly the same as pliers 5809-1



DV-22-1Z
Tweed

Single diameter loop forming pliers. Wire up to 0,56 x 0,7 mm. (.022" x 0,28"). Replaceable concave beak has only one diameter section of 1,50 mm. (.059").

Distal end cutters



DV-22-2C

Distal end cutter -safety hold- a precision cutter designed for distal arch cutting in the patient's mouth. It cuts hard wires end holds the loose distal end preventing any damaging of oral tissue. Maximum cutting capacity rectangular wires up to 0,56 x 0,7 mm. (.022" x .020").



DV-22-2A

Micro- distal end cutter - safety hold-. Similar to 3227



DV-22-2B

Direct bondingbracket remover (wide). The removal grip firmly for easy incisal-gingival (vertical) use or, if needed, for mesial-distal (horizontal) use with the same ease.



DV-22-2D

Direct bond attachment remover (angled). For removing all bonded attachments. May be used mesial-distal-horizontal) or incisal-gingival (vertical) in anterior areas. Angled perfectly for easy access to difficult posterior areas.

Bird beak pliers



DV-22-2G

Wire bending pliers. For wires up to 0,9 mm. (.036").



DV-22-2E

Bird Beak Angle pliers for bending round, square or rectangular wire up to 0,7 mm. (.028").



DV-22-2F

Double rounded jaw wire bending pliers. For wires up to 0,7 mm. (.028").



DV-22-2H

Bird beak pliers for bending round, square or rectangular wire up to 0,7 mm. (.028"). With cutter.



DV-22-2I

Double rounded jaw wire bending pliers. For wires up to 0,7 mm. (.028").



DV-22-2J
USA Model
125 mm



DV-22-2K
Waldron
125 mm



DV-22-2L
How 140
mm



DV-22-2M
How 145
mm

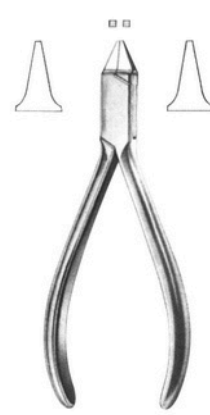

DV-22-2N
Adams
125 mm



DV-22-2O
Angle 125
mm



DV-22-2P
young 130
mm



DV-22-2Q
Nance 130
mm



DV-22-2R
Weingart
140 mm



DV-22-2S
Johnson
130 mm



DV-22-2T
Mc Kellops
155 mm



DV-22-2U
Universal
150 mm



DV-22-2V
Waldsachs
155 mm

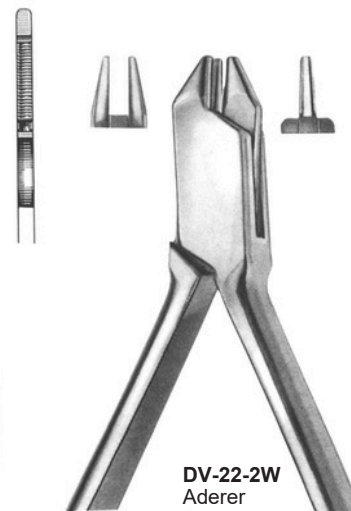

DV-22-2W
Aderer
125 mm



DV-22-2X
Nance 130
mm



DV-22-2Y
Langenbeck
140 mm



DV-22-2Z
Langenbeck
130 mm



DV-22-3A
Langenbeck
130 mm



DV-22-3B
Peeso 125
mm



DV-22-3C
Goslee
125 mm

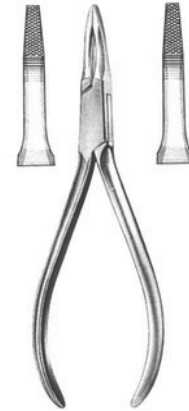

DV-22-3D
Fischer
140 mm



DV-22-3E
Andresen
130 mm



DV-22-3F
Schwarz
130 mm

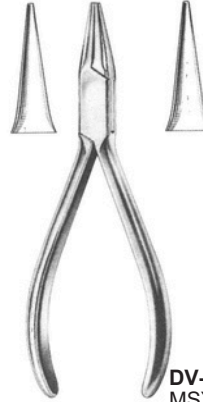

DV-22-3G
MSY 130
mm

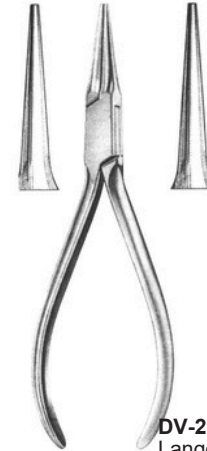

DV-22-3H
Langenbeck
125 mm



DV-22-3I

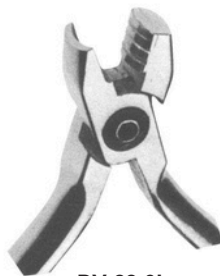

DV-22-3J



DV-22-3K



DV-22-3L



DV-22-3M



DV-22-3N



DV-22-3O



DV-22-3P



DV-22-3Q

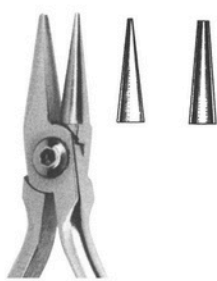

DV-22-3R

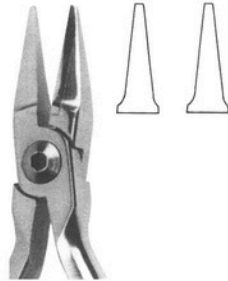

DV-22-3S

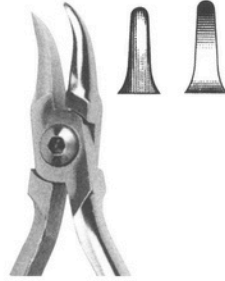

DV-22-3T



DV-22-3U



DV-22-3V



DV-22-3W



DV-22-3X



DV-22-3Y



DV-22-3Z



DV-22-4A

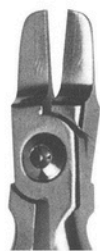

DV-22-4B

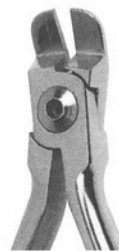

DV-22-4C

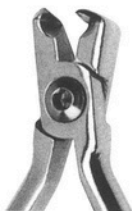

DV-22-4D



DV-22-4E



DV-22-4F



DV-22-4G



Molt
DV-22-4H 10 cm
DV-22-4I cm
DV-22-4J 14 cm
 cm



DV-22-4K 16 cm
DV-22-4L 19 cm
 Roser-König



DV-22-4M
 Denhardt
 13 cm



DV-22-4N
 Fergusson - Ackland
 14.5 cm



DV-22-40
 Heister
 Maunder Wood
 9.5 cm



DV-22-4P
 Obwegeser 1 cm
 Spreading 47 mm



DV-22-4Q
 Heister
 13 cm



DV-22-4R Small
DV-22-4S Medium
DV-22-4T Large
 Cheek Retractor

Tongue Depressors

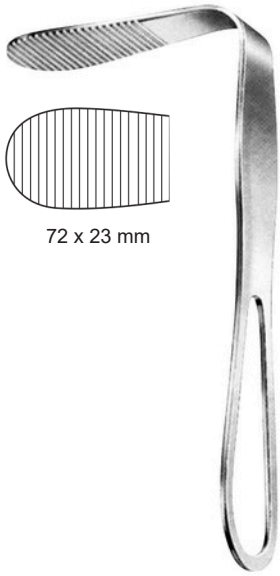

72 x 23 mm

DV-22-4U
Hartmann
15 cm

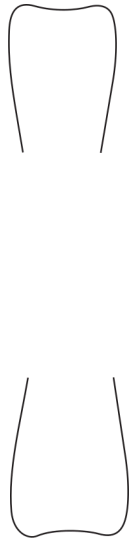

DV-22-4V
Doyen Tongue Spatula
13.5 cm



DV-22-4W
14.5 cm



DV-22-4X
18 cm



DV-22-4Y
Bruenings
19 cm

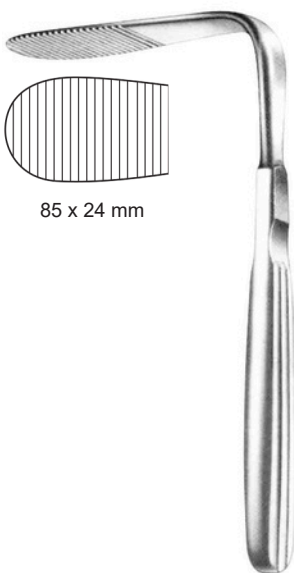

85 x 24 mm

DV-22-4Z
Tobold
15 cm

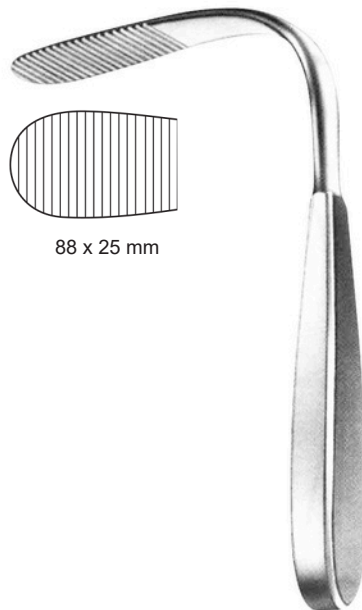

88 x 25 mm

DV-22-5A
Tobold
16 cm

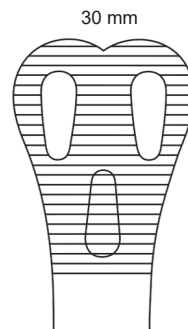

30 mm

DV-22-5B
14 cm

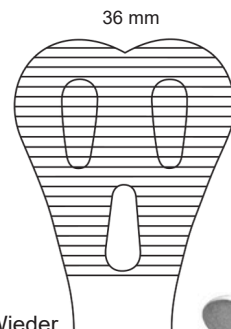

36 mm

Wieder

DV-22-5C
15 cm

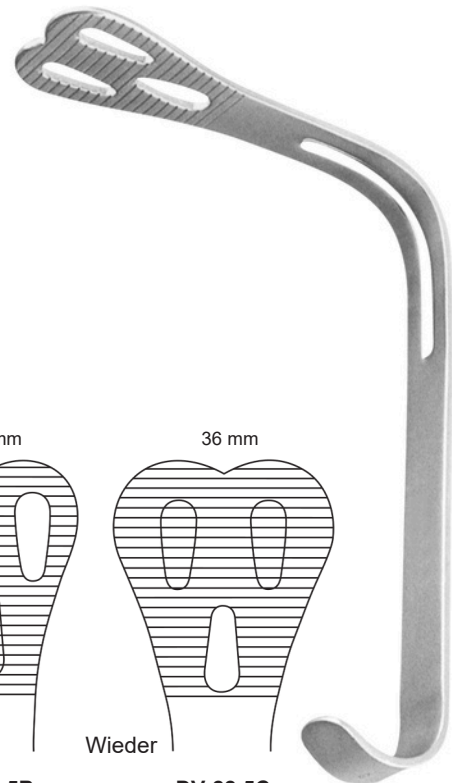

Lip and Cheek Retractors

www.dentovos.com

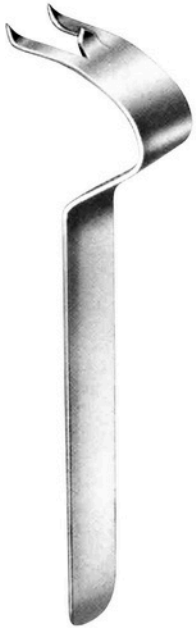

DV-22-5G
Obwegeser Chin
Retractor
16.5 cm



Obwegeser 16 cm
DV-22-5H 8 mm
DV-22-5I 10 mm

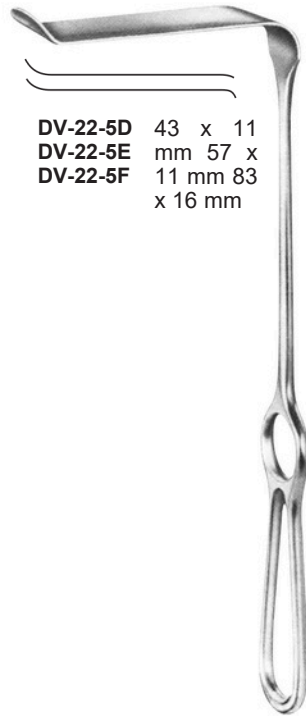

DV-22-5D 43 x 11
DV-22-5E mm 57 x
DV-22-5F 11 mm 83
x 16 mm



35 x 11 mm

DV-22-5J
Obwegeser Spina-
nasalis retractor
22 cm



72 x 11 mm

DV-22-5K
Obwegeser Ramus
retractor for separation
of ramus & tissue 22 cm



DV-22-5L
Simplex
10.5 cm

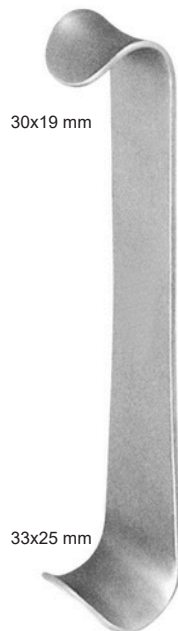

30x19 mm

33x25 mm

DV-22-5M
Kilner 15
cm



DV-22-5N
Minnesota
14 cm



DV-22-5O
Cawood-
Minnesota 15 cm



DV-22-5P
Austin



DV-22-5Q
Hilger Fits any simple stem mouth mirror handle



DV-22-5R
Hilger with handle



DV-22-5S
Max 20 cm

Finger protectors



DV-22-5T Small
DV-22-5U Medium
DV-22-5V Large

Langenbeck

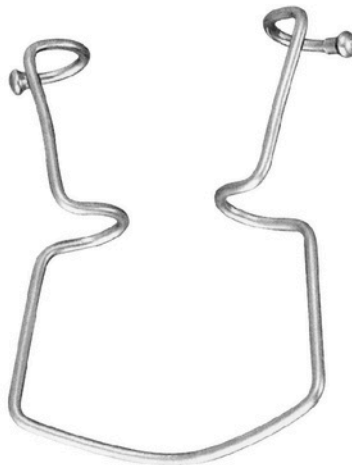

DV-22-5W
Oringer
11.5 cm

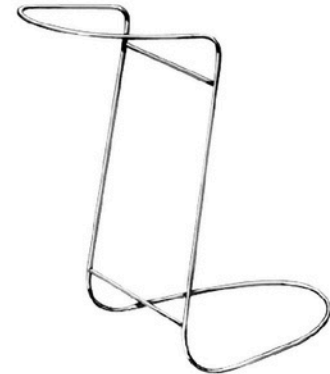

DV-22-5X
Obwegeser Cheek Retractor
12cm



DV-22-5Y
Columbia
14.5 cm



Sternberg

DV-22-5Z 12 cm
DV-22-6A 14 cm
DV-22-6B 15 cm



Vestibulum
DV-22-6C



DV-22-6D
Max

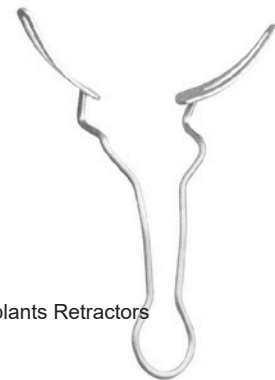

DV-22-6E
Max

Implants Retractors

Retractors

www.dentovos.com

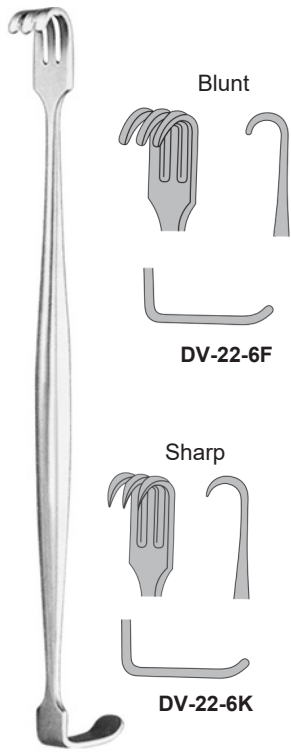

Senn-Miller
16 cm

Blunt
DV-22-6F

Sharp
DV-22-6K



Max
16 cm

Sharp
DV-22-6G
DV-22-6H
DV-22-6I
DV-22-6J



Max
16 cm

Blunt
DV-22-6L
DV-22-6M
DV-22-6N
DV-22-6O

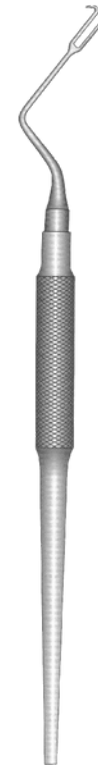

Kirkland
Gum & Tissue
Retractors

DV-22-6P
Fig. 23 K

DV-22-6Q
Fig. 24 K

DV-22-6R
Fig. 27 K

DV-22-6S
Fig. 28 K



DV-22-6U
Collin Tongueholding forcep
17 cm



Young Tongue holding
forcep DV-22-6V 15 cm
DV-22-6W
3 17 cm

DV-22-6T
Rubber Pad
pair



DV-22-6X
Farabeuf
12cm Pair

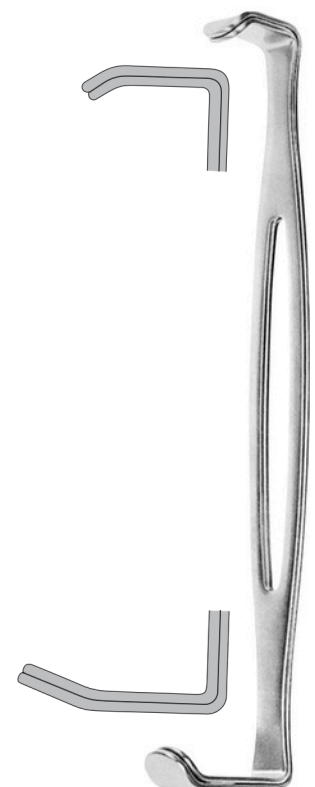

DV-22-6Y
Parker-Langenbeck 21
cm Pair

Osteotomes



15.5 cm

# 1	Diam.
0	Ø1.60
7.5	Ø1.80
10	Ø2.00
13.	Ø2.40
5	Ø3.60
15.	
5	

1
Ø 1.6 mm



DV-22-6Z
15.5 cm

# 2	Diam.
0	Ø1.90
7.5	Ø2.20
10	Ø2.35
13.	Ø3.30
5	Ø3.40
15.	Ø4.50
5	

2
5 Ø 1.9 mm



DV-22-7A
15.5 cm

# 3	Diam.
0	Ø2.80
7.5	Ø3.20
10.5	Ø3.35
13.5	Ø3.60
21	Ø4.40

3
Ø 2.8 mm



DV-22-7B
15.5 cm

# 4	Diam.
0	Ø3.10
7.5	Ø3.70
10.	Ø3.90
5	Ø4.30
15.	
5	

4
Ø 3.10 mm



DV-22-7C
15.5 cm

# 5	Diam.
0	Ø3.90
10	Ø6.00
13	Ø6.20
20.	Ø6.30
5	

5
Ø 3.90 mm



DV-22-7D
15.5 cm

#	Diam.
6	Ø6.50
0	Ø6.20
10	Ø6.30
13	

6
Ø 5.50 mm



DV-22-7E
15.5 cm

#	Diam.
1	Ø1.50
0	Ø1.90
5	Ø2.20
8	Ø2.40
10	Ø2.60
12	Ø2.80
14	

1
Ø 1.5 mm



DV-22-7F
15.5 cm

# 2	Diam.
0	Ø2.10
5	Ø2.60
8	Ø2.80
10	Ø3.00
12	Ø3.20
14	Ø3.40

2
Ø 2.1 mm



DV-22-7G
15.5 cm

# 3	Diam.
0	Ø2.60
5	Ø3.00
8	Ø3.30
10	Ø3.50
12	Ø3.70
14	Ø3.90

3
Ø 2.6 mm



DV-22-7H
15.5 cm

# 4	Diam.
0	Ø3.00
5	Ø3.50
8	Ø3.80
10	Ø4.00
12	Ø4.20
14	Ø4.40

4
Ø 3.0 mm



DV-22-7I
15.5 cm

# 5	Diam.
0	Ø3.50
5	Ø3.90
8	Ø4.20
10	Ø4.40
12	Ø4.60
14	Ø4.80

5
Ø 3.5 mm



DV-22-7J
15.5 cm

Ø 2.8 mm



DV-22-7K
15.5 cm

Spelling Straight
Bone Pusher

Ø 3.5 mm



DV-22-7L
15.5 cm

Ø 4.2 mm



DV-22-7M
15.5 cm

Osteotomes

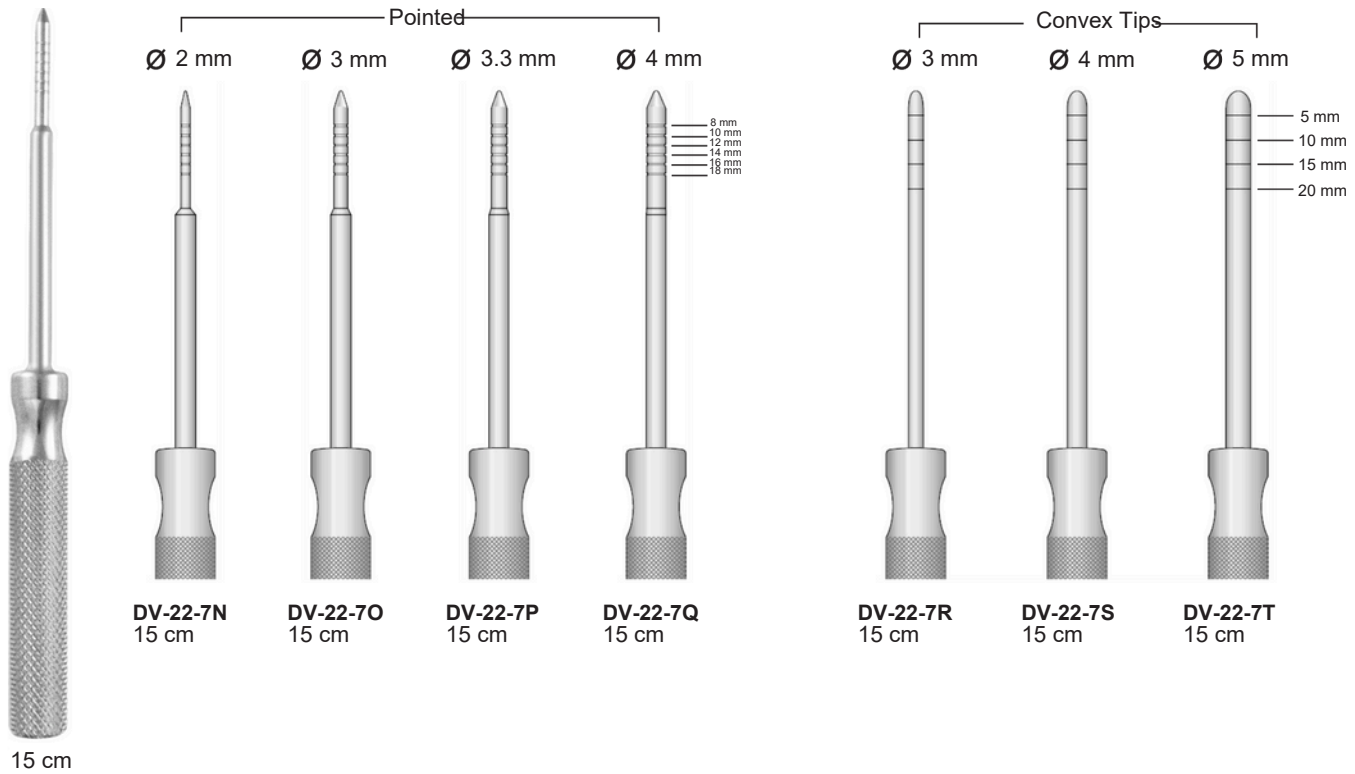

Convex Tips

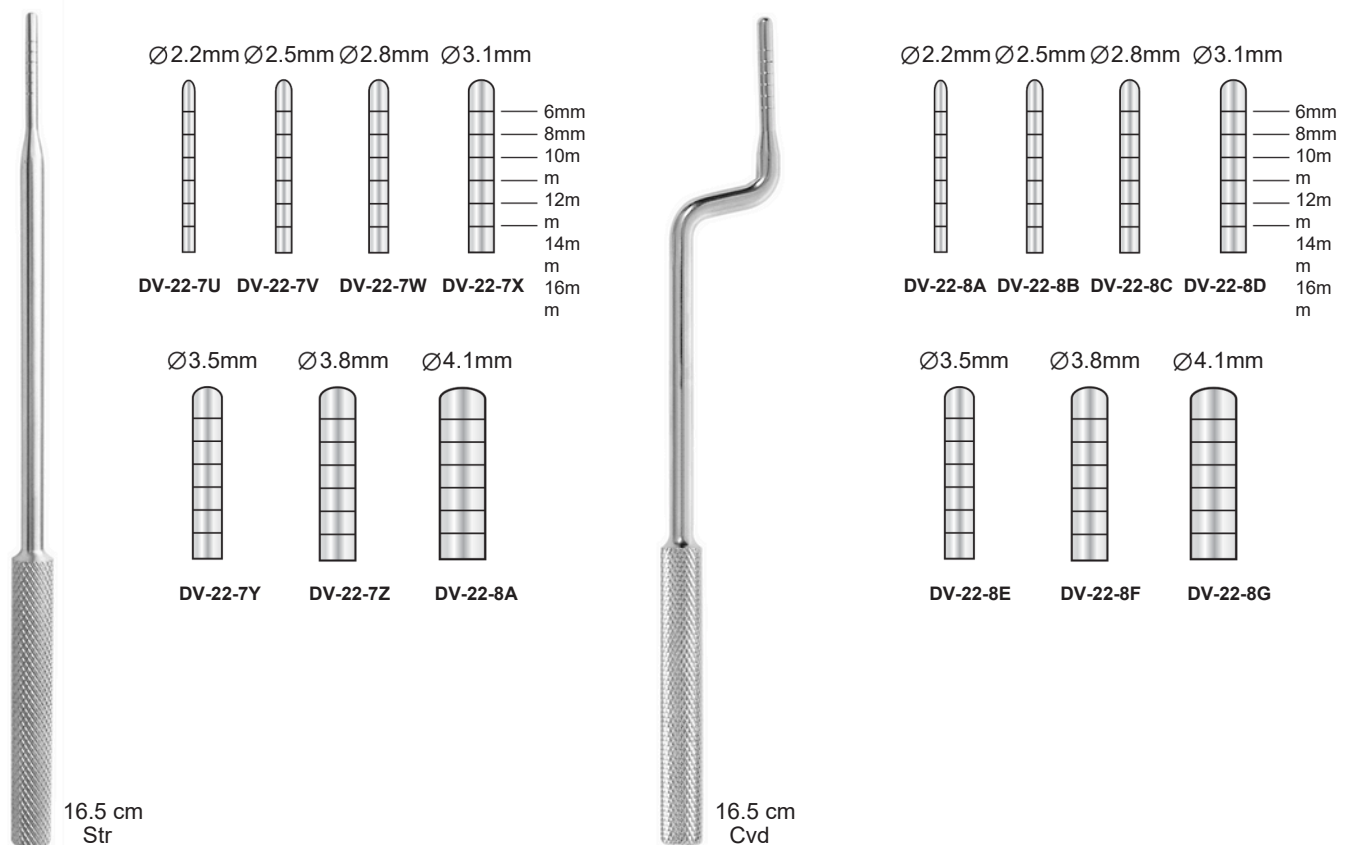

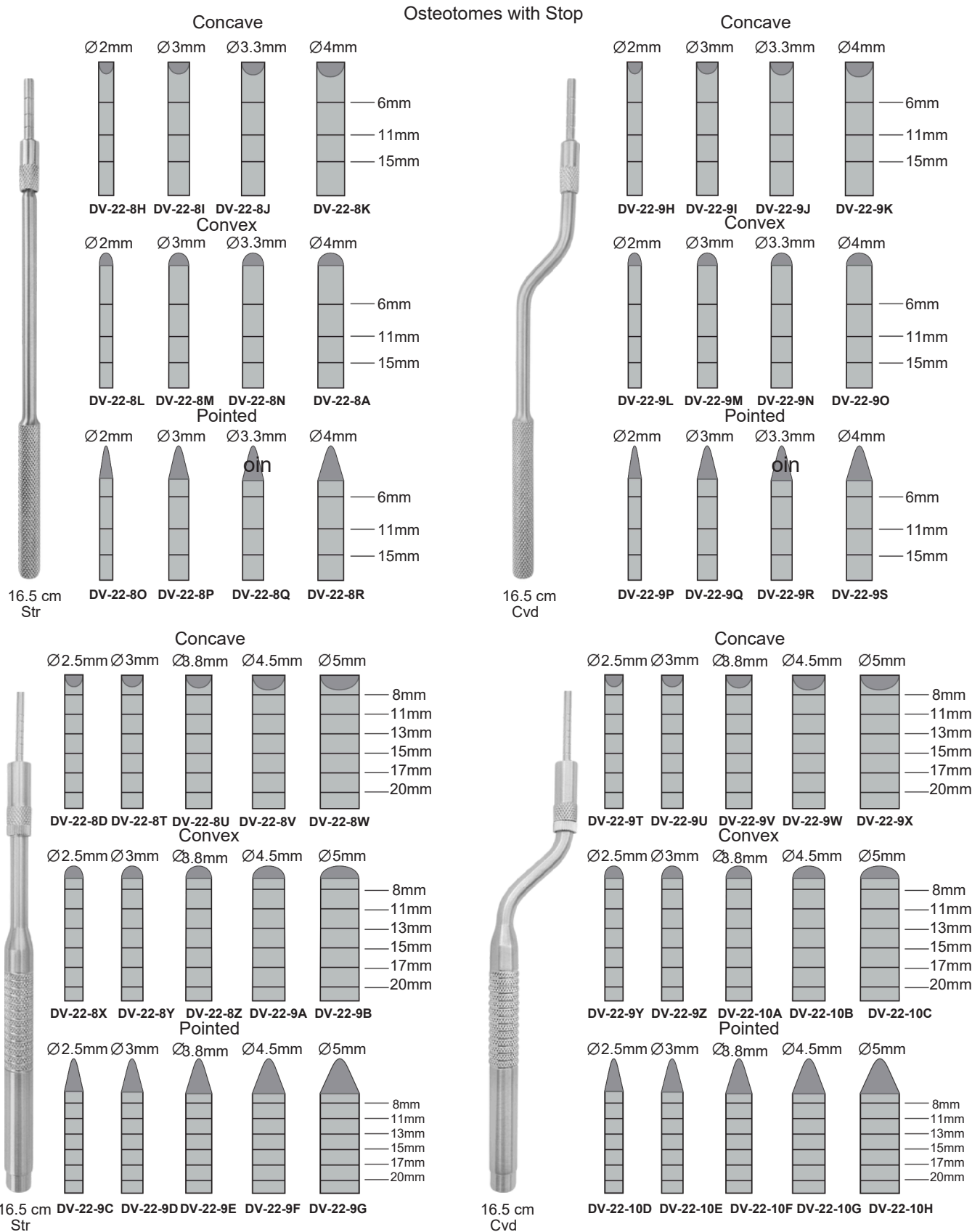

PDL Elevators



DV-22-10I Distal, 2.5 mm Micro Edge



DV-22-10J Mesial, 2.5 mm Micro Edge



DV-22-10K Distal, 4 mm Micro Edge



DV-22-10L Mesial 4 mm Micro Edge



DV-22-10M 2.5 mm Micro Edge,



DV-22-10N ^{Straight} 2.5 mm Micro Edge, Curved

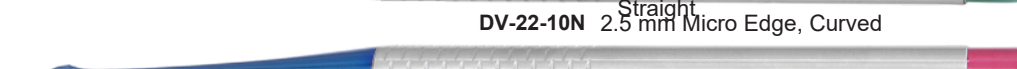

DV-22-10O 3.4 mm Straight

DV-22-10P Set Of 7 Pieces



DV-22-10Q Distal, 2.5 mm Micro Edge



DV-22-10R Mesial, 2.5 mm Micro Edge



DV-22-10S Distal, 4 mm Micro Edge



DV-22-10T Mesial 4 mm Micro Edge



DV-22-10U 2.5 mm Micro Edge, Straight



DV-22-10V 2.5 mm Micro Edge, Curved

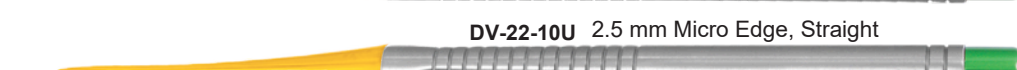

DV-22-10W 3.4 mm Straight

DV-22-10X Set Of 7 Pieces



Instruments Tray

Trephine Drills



DV-22-10Y
Interior 2 mm
Exterior 3 mm

DV-22-10Z
Interior 3 mm
Exterior 4 mm

DV-22-11A
Interior 4 mm
Exterior 5 mm

DV-22-11B
Interior 5 mm
Exterior 6 mm

DV-22-11C
Interior 6 mm
Exterior 7 mm

DV-22-11D
Interior 7 mm
Exterior 8 mm

DV-22-11E
Interior 8 mm
Exterior 9 mm

DV-22-11F
Interior 9 mm
Exterior 10 mm

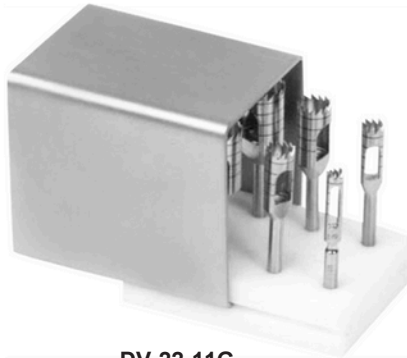

DV-22-11G
Trephine Drills
Stand Complete
with drills



DV-22-11H
Trephine Drills
Stand Complete
with drills

Tissue Punches



Keys

- DV-22-11I 2mm
- DV-22-11J 3mm
- DV-22-11K 4mm
- DV-22-11L 5mm

- DV-22-11M 6mm
- DV-22-11N 7mm
- DV-22-11O 8mm



Keys

- DV-22-11P 3mm
- DV-22-11Q 4mm
- DV-22-11R 5mm
- DV-22-11S 6mm

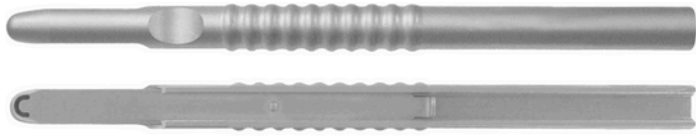

DV-22-11T
BoneCollector Chisel Straight



DV-22-11U
Blade for Straight bone collector chisel



DV-22-11V
BoneCollector Chisel Curved



DV-22-11W
Blade for Curved bone collector chisel



DV-22-11X
Ratchet Screw driver handle
Hexagonal head



DV-22-11Y
Bone Morselizer with Titanium Grinding



DV-22-11Z
Bone Mixing
Basin Dia 35
mm

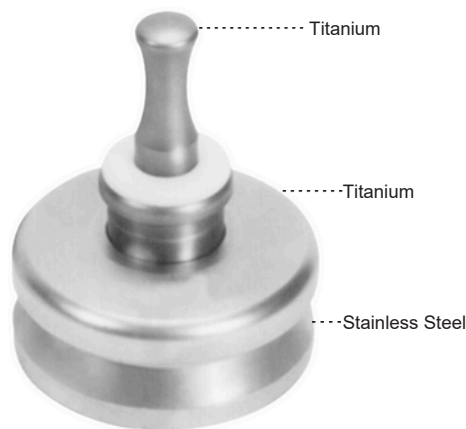

DV-22-12A
Manual Easy Bone Mill



DV-22-12B
Bone Craker Titanium

The logo for Dentovos, featuring the word "DENTOVOS" in a bold, dark blue, sans-serif font. A thin, light blue diagonal line crosses through the letter "O" from the top-left to the bottom-right.

Page
152-155

- Impression Trays

www.dentovos.com

All Impression Trays Upper & Lower Type
are available in S, M, L & XL Sizes



DV-23-1A
"HYDRO-LOCK"
stainless steel
water-cooled
impression trays
with retention rim.



DV-23-1B
"HYDRO-LOCK"
stainless steel water-
cooled impression trays
with retention rim.



DV-23-1C
"NEWSUPER"
stainless steel
impression trays
with retention rim.



DV-23-1D "NEW SUPER"
stainless steel impression
trays with retention rim.



DV-23-1E
"ANATOMIC" solid
regular stainless
steel impression
trays without
retention rim.



DV-23-1F
"ANATOMIC" solid regular
stainless steel impression
trays without retention rim.



DV-23-1G
Perforated-total denture
stainless steel impression
trays with rim.



DV-23-1H
Perforated-total denture
stainless steel impression
trays with rim.

All Impression Trays Upper & Lower Type are available in S, M, L & XL Sizes



DV-23-1I
"PERMA-LOCK" solid regular stainless steel impression trays with retention rim.



DV-23-1J
"PERMA-LOCK" solid regular stainless steel impression trays with retention rim.



DV-23-1K



DV-23-1L



DV-23-1M



DV-23-1N



DV-23-1O



DV-23-1P



DV-23-1Q
Set of six

PACKINGS



DV-23-1R
Set of Eight



DV-23-1S
Solid stainless steel anterior depressed impression trays with retention rim.



DV-23-1T



DV-23-1U



DV-23-1V



DV-23-1W



DV-23-1X



DV-23-1Y



DV-23-1Z
Solid stainless steel anterior depressed impression trays with retention rim.

All Impression Trays Upper & Lower Type
are available in S, M, L & XL Sizes



DV-23-2A
Fig.0perbambini - for children

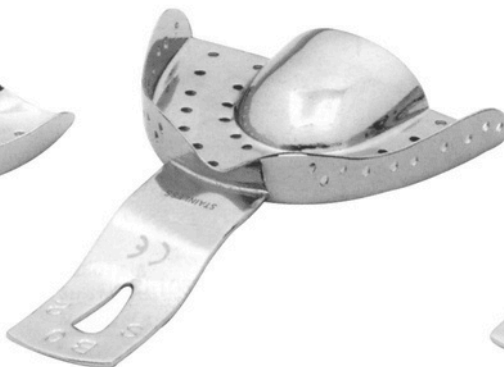

DV-23-2B
Fornarrowtoothed upper jaws



DV-23-2C
Fig.0perbambini - for children



DV-23-2D
Forpartiallytoothed upper jaws



DV-23-2E
Forpartiallytoothed lower jaws



DV-23-2F
Foredentulous upper jaws



DV-23-2G
Foredentulous lower jaws

All Impression Trays Upper & Lower Type are available in S, M, L & XL Sizes



DV-23-2H
Solid total denture stainless steel impression tray with rim.



DV-23-2I
Solid total denture stainless steel impression tray with rim.



DV-23-2J
"PERMA-LOCK" perforated regular stainless steel impression trays with retention rim.



DV-23-2K
"PERMA-LOCK" perforated regular stainless steel impression trays with retention rim.



DV-23-2O
Perforated stainless steel anterior depressed impression trays with retention rim.

DV-23-2P

DV-23-2Q

DV-23-2R



DV-23-2L



DV-23-2M



DV-23-2N



DV-23-2S
Perforated stainless steel anterior depressed impression trays with retention rim.



DV-23-2T Perforated stainless steel impression trays without retention rim for complete denture.



DV-23-2U Perforated stainless steel impression trays without retention rim for complete denture.

DENTOVOS

Page
156-157

- Arriculators

www.dentovos.com

Articulators



DV-24-1A



DV-24-1B



DV-24-1C



DV-24-1D



DV-24-1E



DV-24-1F



DV-24-1G



DV-24-1H



DV-24-1I



DV-24-1J

The logo for Dentovos, featuring the word "DENTOVOS" in a bold, dark blue, sans-serif font. A thin, light blue diagonal line crosses through the letter "O" from the top right to the bottom left.

DENTOVOS

Page
158-160

- Dental Surgical Hollowares

www.dentovos.com

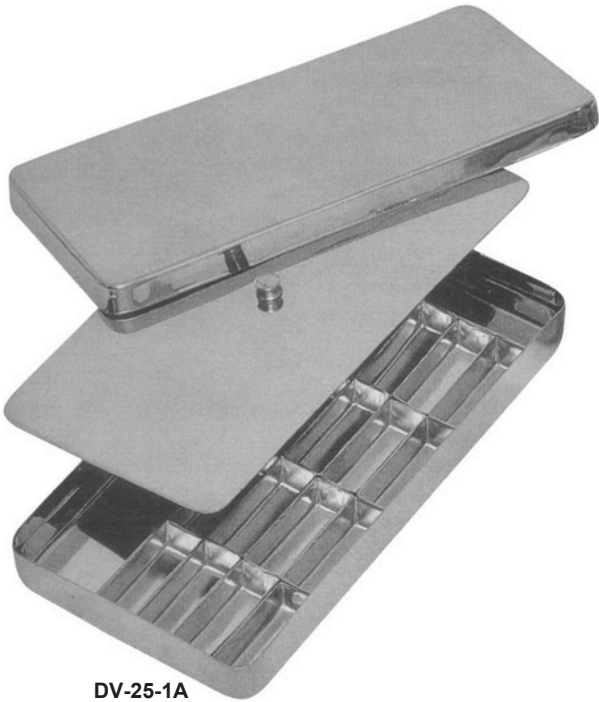

DV-25-1A
ENDODONTICBOX



DV-25-1B
STERILIZINGBOX
Available in dif. sizes
17x17x3 cm 20x10x4
cm 25x12x6 cm
30x14x6 cm



DV-25-1C ENDO
TRAY BOX

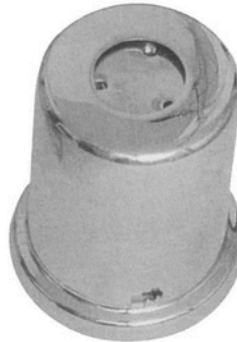

DV-25-1D
COTTONDISPENSER

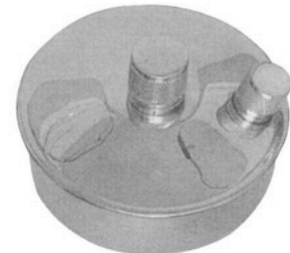

DV-25-1E
ALCOHOLLAMP

Sterilizing Drums



DV-25-1F



DV-25-1G

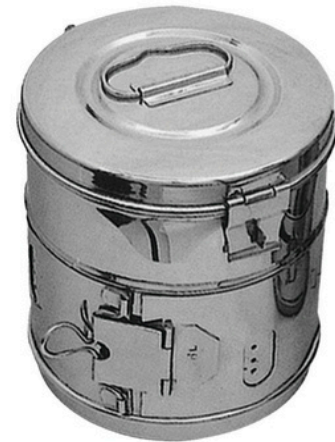

DV-25-1H

Sterilizing Boxes



DV-25-1I



DV-25-1J



DV-25-1K

Sterilizing Boxes



DV-25-1L



DV-25-1M



DV-25-1N



DV-25-1O



DV-25-1P



DV-25-1Q

FORCEP AND THERMOMETER JARS

COTTON DISPENSER



DV-25-1R
IRRIGATOR(Douchcan)



DV-25-1S
MEASURINGJUG



DV-25-1T
KIDNEY TRAY



DV-25-1U
FORCEP JAR



DV-25-1V
GALLIPOT WITH & WITHOUT LID



DV-25-1W
SPITTEN MUG



DV-25-1X
SPIRIT LAMP



DV-25-1Y
Perforated Tray



DV-25-1Z
Perforated Base



DV-25-2A
Solid Base



DV-25-2B
Instruments Tray



DV-25-2C
Instruments Tray



DV-25-2D
Instruments Tray
(Perforated)



DV-25-2E
Instruments Tray Shallow
(Mayo)



DV-25-2F
Scalers Tray



DV-25-2G
Catheter Tray

DENTOVOS



92-340-17817219, 92-302-61952315



info@dentovos.com, sales@dentovos.com



www.dentovos.com

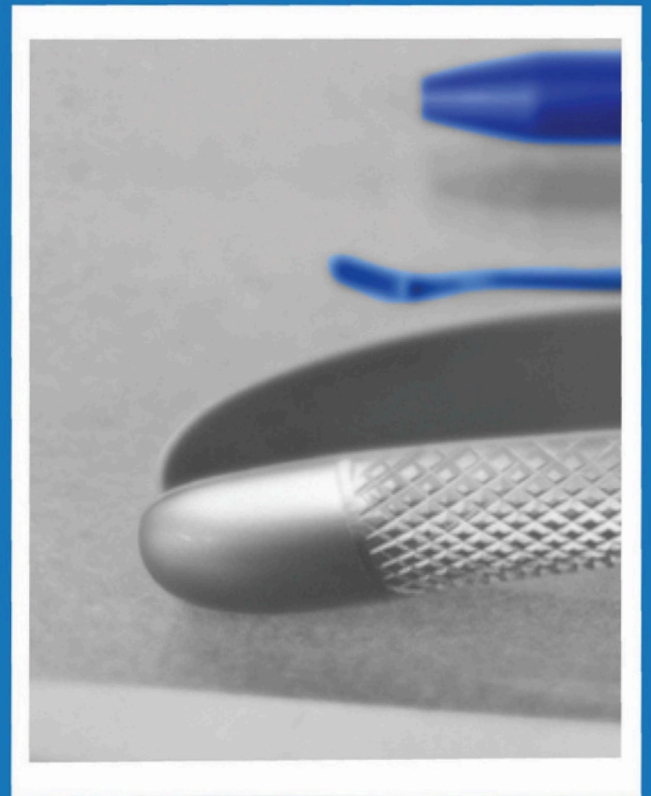

Our Certifications:

ISO 9001

CE Certified

EN 13485:2012

ISO 7153-1

ISO 7151

ISO 17664:2004

ISO 13402

ISO 15223

